



# ROADSHOW JR.

## Instruction Manual

Congratulations on your purchase!

For optimum performance, please read this Instruction Manual before playing.

### ■ Contents

- Bass Drum Shell ..... x1
- Bass Drum Heads ..... x1pr
- Bass Drum Hoops ..... x1pr
- Bass Drum Tension Rods, Claws ..... x12
- Tom Tom (S) ..... x1
- Tom Tom (L) ..... x1
- Tom Holder ..... x2
- Floor Tom Shell ..... x1
- Floor Tom Heads ..... x1pr
- Floor Tom Hoops ..... x1pr
- Floor Tom Tension Rods ..... x12
- Floor Tom Legs ..... x3
- Hi-Hat Stand ..... x1
- Drum Pedal ..... x1
- Snare Drum ..... x1
- Snare Stand ..... x1
- Cymbal Stand ..... x1
- Drum Throne ..... x1
- Hi-Hat Cymbal ..... x1pr
- Cymbal ..... x1
- Sticks ..... x2pr
- Tuning Key ..... x1
- Rubber Hoop Protector ..... x1
- Grease ..... x1
- Bass Drum Tension Rods (Spare) ..... x1
- Floor Tom Tension Rods (Spare) ..... x1
- Lug Nut (Spare) ..... x1



# SAFETY PRECAUTIONS FOR ASSEMBLY AND USE

Thank you for choosing Pearl! Before use, please follow these instructions carefully for safe and proper assembly and operation of your drums, stands, pedals, and accessories. Please keep these instructions in a safe place for future reference.

## Hazard Signs

The three Hazard Signs, as shown below, appear periodically throughout the product instructions to alert the user or others to possible danger or injury. For safe assembly and use of this, or any Pearl product, never ignore a Hazard Sign and ensure the threat level and corresponding instructions are entirely understood.

<b>⚠ Warning</b>	<b>⚠ Caution</b>	<b>🚫 Note</b>
<b>Risk of fatal or severe personal injury and/or property damage.</b>	<b>Risk of injury to person(s) handling the equipment and/or to personal property.</b>	<b>The performance or function of the equipment may be adversely affected and may result in permanent damage.</b>

● Pearl Musical Instrument Company and Affiliates cannot be held responsible for personal injuries or property damage caused by the misuse, improper handling, failure to follow product warnings and instructions, or product use outside of its intended purpose.

### SAFETY PRECAUTIONS

#### ⚠ Warning

##### Tighten and Secure All Moving Parts

Ensure all wing bolts, wing nuts, geared tilters, bass drum spurs, and clamps are tight and secure after assembly or adjustment. Failure to do so will cause the hardware to fall over or drop/slip during use and may result in personal injury or property damage.

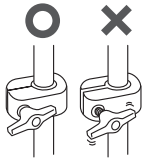

#### ⚠ Caution

##### Avoid Damage To Floor Surfaces

The bass drum spurs and hi-hat stands have sharp tips/anchors to keep them stationary during use. The pointed ends may gouge or damage bare floors, and the rubber tips may cause discoloration to floor surfaces if left in place over time. To prevent floor surface damage, always place the drum-set on carpet or a specially designed drum mat.

##### Stabilizing Stands

Open the tripod base to a wide stance to ensure stability and prevent the stand from tipping over during use. When mounting a tom or boom cymbal, always position them directly over a leg of the tripod for optimum stability.

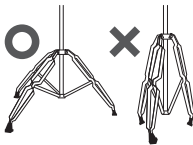

##### Be Careful Around Drum Sets and Stands

Hardware, drums, cymbals, and percussion devices protruding from drum sets may cause people walking by or children playing nearby to trip and stumble into the drum set resulting in severe bodily injury and/or damage to equipment. Exercise extreme caution when moving about your set and closely supervise children who may be playing in the vicinity of your set.



##### Earthquake Precautions

A strong vibration such as an earthquake can cause your drums and hardware to shift and tip over. Stay well clear of falling objects to avoid injury.

#### Adjustments

Use two hands when adjusting the height and angle of drums, cymbals, practice pads, etc. Use one hand to support the object being adjusted to keep it from falling while making adjustments with your other hand.

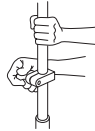

#### Precautions When Handling Equipment

#### ⚠ Warning

##### Objects with Rough or Pointed Shapes

Some parts, such as knurled posts, hi-hat rods, and tension rods have roughened or pointed shapes that can scratch surfaces or get caught, for example, on clothes or carrying bags. Please handle these parts with extra caution to avoid mishaps.

##### Bass Drum Head Sound Control Hole

Some bass drum heads are equipped with a hole for sound control and microphone placement. The edges of the hole are sharp; use caution to avoid contact to prevent injury when handling, placing microphones, or muffling the drum.

##### Anti-Slip Spikes

The spikes (used on bass drum spurs, hi-hat legs, snare stand legs and some other products) are sharp and can cause serious personal or property injury. To prevent mishaps, use extreme care when handling these products especially when the spike tips are exposed.

##### Folding Stand Legs

When folding the legs on stands, be careful not to pinch your fingers between any moving parts.

##### Handling Tubing

Do not put your fingers into the tubes when handling tubular hardware. Doing so may result in injury.

##### Adjusting Throne Settings

Sitting on a drum seat while adjusting height settings can cause the seat to drop suddenly and pinch your fingers and/or cause other bodily injuries. Sitting on the drum seat while making adjustments may require twisting and reaching that can also cause bodily injuries. To prevent injury, perform these adjustments before sitting, test, and repeat as necessary until the best comfort/support is achieved.

##### Be Careful Using Sticks and Wire Brushes

Sticks and wire brushes are intended for playing the drums and should never be used to hit or to be thrown at people. Doing so can be extremely dangerous.

##### Broken Sticks

Fragments and splinters from broken drumsticks can fly into the air and cause injury to the player and/or to those nearby.



#### The Drum Throne is Not a Step Stool

Standing on a drum throne and using it as a step stool may cause it to break and fall over. Never use the drum throne for anything other than its designated purpose, that is, to sit on while playing.



#### ⚠ Caution

##### Precautions with Oil and Grease

Hardware such as tension rods, wing nuts, and wing bolts are lubricated with grease or oil from the factory. Use caution when handling to avoid skin or clothing contact. If exposed, wash any surface with soap and water immediately.

##### Precautions with Rust or Sharp Edges

Metal parts may become rusty and scratched through use. Rusty surfaces can be sharp, and care must be taken to prevent injury to your hands and feet. Metal surfaces, such as footboards, may develop sharp edges from contact with other stands, especially during transport. Examine metal parts periodically and repair them immediately to prevent injury to your hands and feet.

#### 🚫 Note

##### Metal Care

To prevent rust, all metal parts on drums and hardware should be wiped with a clean dry cloth immediately after exposure to moisture. Periodically polish metal parts to protect against rusting and to maintain the beauty of fittings and hardware. Should rust occur, remove the rust with commercial removal products and use caution to prevent cuts to your hands from sharp edges that may be present.

##### Precautions Regarding High Temperatures and Humidity

Leaving your drums in places with high heat, such as in a car or in direct sunlight, can cause the covering to come loose. To maintain the pristine condition of your drums and hardware, store them in places with controlled and comfortable temperature and humidity.

##### Precautions Regarding High Temperatures and Ultraviolet Light (UV from the Sun)

To maintain the pristine condition of your drum finish covering, avoid long periods of exposure to Ultraviolet Light (direct Sun-Light) or very high temperatures.

California Proposition 65



## Bass Drum Assembly

The bass drum is shipped unassembled. Please follow the assembly instructions below.

1. Place the shell with the Spur Bracket facing upward on a clean, solid surface. Put the Pearl logo head on the shell, followed by the hoop, and position the hoop inlay seam between the bottom two lugs (Fig.1).
2. Insert a tension rod through the claw, place it on the hoop, and insert it into the lug nut of the lug. Then finger tighten and repeat on each lug until this side is complete.

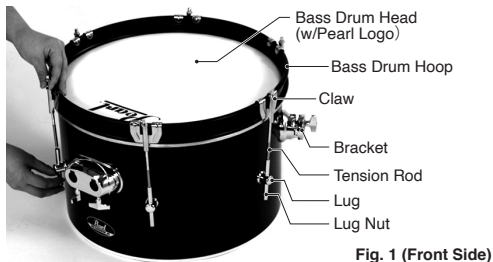

Fig. 1 (Front Side)

3. Turn the drum over and attach the other head and hoop using the remaining tension rods/claws.
4. Position the drum upright and install the bass drum spurs as shown with the front of the drum about an inch off the floor. Check to ensure the spur stop locks are positioned correctly into the corresponding bracket and tighten to secure. Double-check that all wing nuts are tight, then tune to the desired pitch (Fig.2).

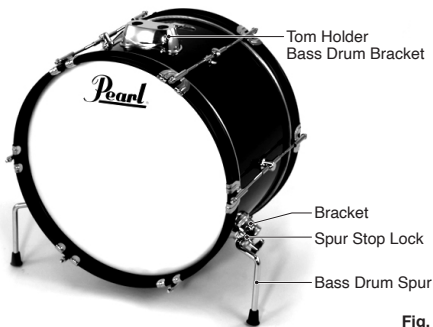

Fig. 2

4. The rubber hoop protector is attached to the bass drum hoop by double-sided tape. To install, remove the tape adhesive cover and attach the rubber hoop protector to the inside drum hoop, centered between the two bottom claws (Fig.3).

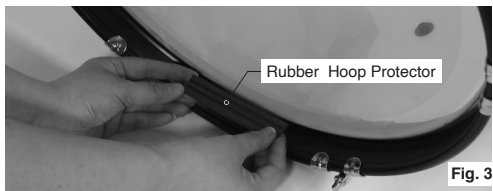
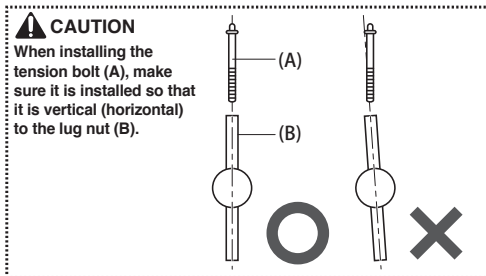

Fig. 3



## Tom Tom Assembly

1. Insert the two tom holders into the bracket on the bass drum with wing nuts facing outward as shown. Each tom holder is equipped with a stop lock that fits into the bass drum and tom brackets. The stop locks keep the drums from rotating while in use and memorize position settings for quick and repeatable set-ups (Fig.4).
2. Next, attach the toms to the tom holders and position the height and angles to your preference. When satisfied, set the stop lock into the slots in the tom holder brackets and tighten using the supplied tuning key to retain these settings (refer to the Set-Up Example illustration on the first page of this manual) (Fig. 4 & 5).

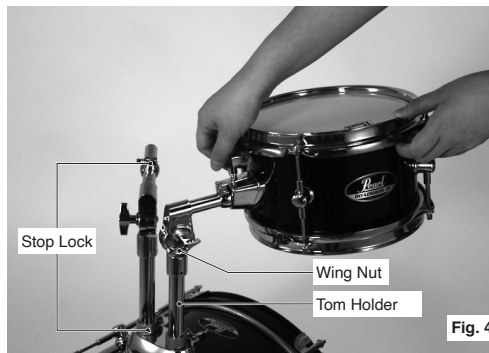

Fig. 4



Fig. 5

## Floor Tom Assembly

1. Place the shell on a clean, solid surface with the floor tom leg brackets closest to the table. Next, put the head on the shell, followed by the steel hoop.
2. Insert a tension rod through an ear of the steel hoop and finger-tighten it into the lug nut of the lug. Repeat this for the remaining lugs until the hoop and head are attached to the drum. (Fig.6).

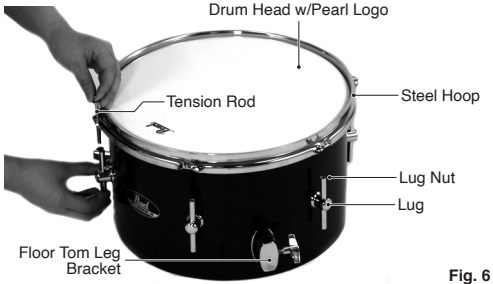

Fig. 6

3. Turn the drum over and attach the other head and hoop with the remaining tension rods.
4. Attach the floor tom legs to the floor tom leg brackets as shown and set the height and tilt to your preference (Fig.7).



Fig. 7

**CAUTION**  
When installing the tension bolt (A), make sure it is installed so that it is vertical (horizontal) to the lug nut (B).

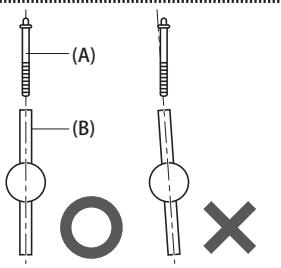

## Hi-Hat Stand Assembly

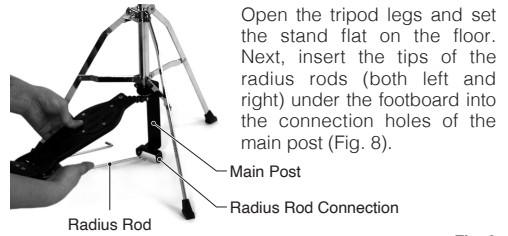

Fig. 8



Fig. 9

Open the tripod legs and set the stand flat on the floor. Next, insert the tips of the radius rods (both left and right) under the footboard into the connection holes of the main post (Fig. 8).

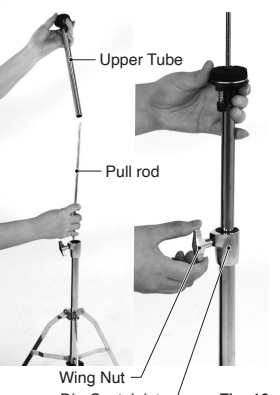

Fig. 10

**Upper Section.**  
Lower the upper tube with the plastic cup at the top onto the pull rod to insert it into the lower assembly. Set the upper tube to the desired height, and tighten the wing bolt (Fig.10).

Next, place one of the two hi-hat cymbals on the felt of the plastic cup (Fig.11).

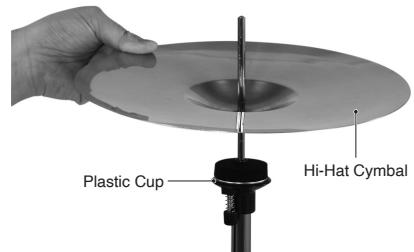

Fig. 11

Attach the other cymbal to the hi-hat clutch, placing it between the two felts, then tightening the clutch nut to secure. Next, lower the hi-hat clutch onto the pull rod (Fig. 12).

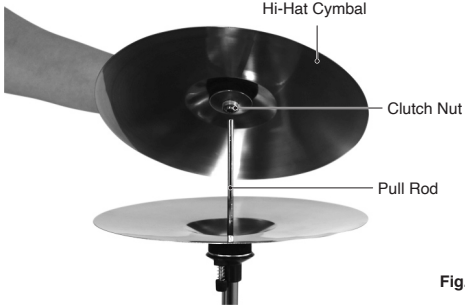

Fig. 12

To adjust the cymbal spacing, depress the footboard pedal and tighten the Hi-Hat Clutch wing bolt at a point where there is a moderate gap between the upper and lower cymbals (Fig. 13).



Fig. 13

## Drum Pedal Assembly

Insert the end of the radius rod (both left and right) under the footboard into the connection (holes) of the main post (Fig. 14).

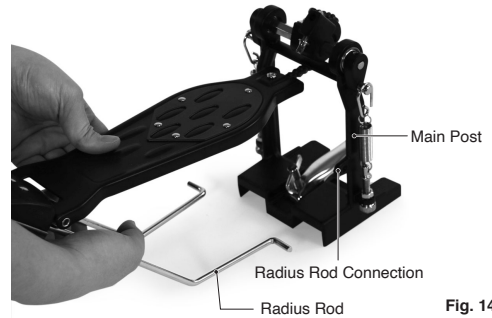

Fig. 14

Insert the beater shaft into the hole of the beater holder and secure it by tightening the key bolt with the supplied tuning key (Fig. 15).

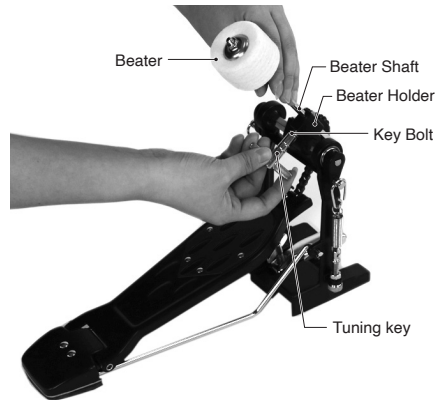

Fig. 15

To install the pedal to the bass drum, attach the hoop clamp located under the footboard onto the bass drum hoop and secure it with the wing bolt (Fig. 16). Ensure that the rubber hoop protector is attached to the bass drum hoop, as noted in Step 4.

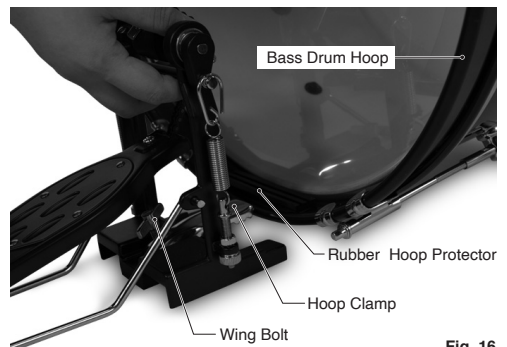
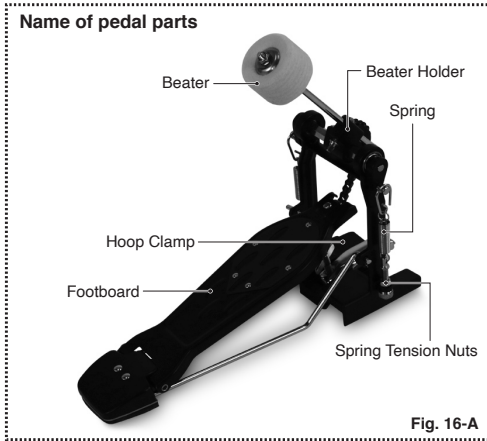

Fig. 16

## Spring Tension

Test the pedal and adjust the spring tension to your preference by adjusting the upper and lower nuts below the spring. To change the spring tension, loosen the top spring tension nut and tighten the bottom nut for more spring tension or loosen for less. Then tighten the top nut to secure your setting (Fig. 16-A).



## Snare Stand Assembly

1. Open the legs of the stand to form a stable tripod and tighten the tripod wing bolt. Then insert the top section into the base and tighten the base collar wing bolt. Ensure both wing bolts are tight and the stand is stable.
2. Open the basket and pull out the slidabale arm to accommodate the snare drum diameter. Place the snare drum into the basket to rest on two of the basket arms, and push the slidabale arm of the basket inward to hold the drum firmly. Each vertical section with rubber tips of the snare basket should contact the outside of the drum hoop. Loosen the angle adjustment nut to adjust the tilt, set it to your desired angle, and tighten. To change the height of the drum, loosen the base collar wing bolt, lift or lower the upper section to your desired height, then tighten to secure (Fig. 17).



### Hint

Position the drum in the basket to conveniently operate the strainer with your left hand (Fig. 17).

### Note

**For optimal stability, one leg should be placed in the same direction as the tilt of the drum. (Fig. 18)**

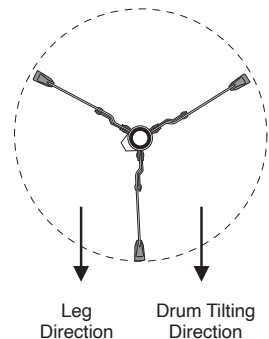

## Cymbal Stand Assembly

1. Open the legs of the stand to form a stable tripod and tighten the tripod wing bolt. Then insert the top section into the base and tighten the base collar wing bolt. Ensure both wing bolts are tight and the stand is stable.
2. Place the cymbal between the two felts on the cymbal tilter located at the top of the stand. Then add the metal washer and top wing nut and tighten to set. Loosen the tilter wing bolt to adjust the tilt, set it to your desired angle, and tighten. To change the height of the cymbal, loosen the base collar wing bolt, lift or lower the upper section to your desired height, then tighten to secure (Fig.19).

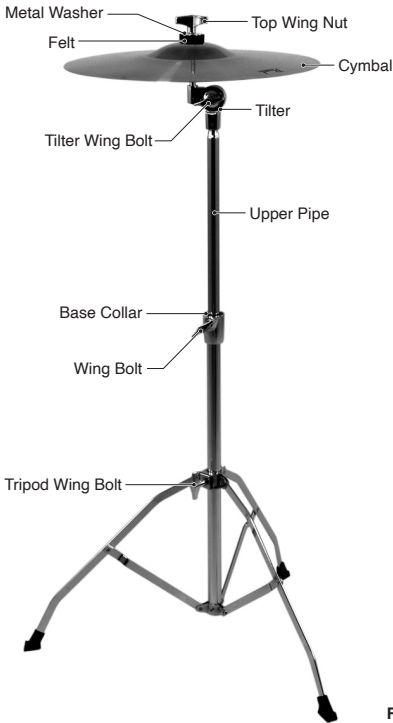

Fig. 19

## Drum Throne Assembly

1. Insert the carriage bolt into one of the large height adjustment holes in the upper pipe, insert the washer onto the bolt on the other side, and lightly secure it with the handle nut (Fig.20).

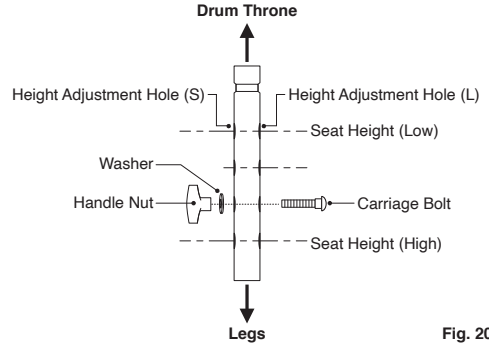

Fig. 20

### Hint

The seat height can only be changed by choosing one of the height adjustment holes.

2. Open the legs of the throne to form a stable tripod and insert the upper pipe into the base. Check to ensure the carriage bolt rests in the corresponding slots located at the top of the base joint with the washer on the outside, then tighten. Attach the seat cushion to the upper pipe. Ensure the upper tube is fully inserted into the seat collar to allow the seat wing bolt to contact the groove at the top of the upper tube. Then tighten to secure.

To change the height of the seat cushion, choose the desired height adjustment holes in the upper tube and reinstall the carriage bolt (Fig.21).

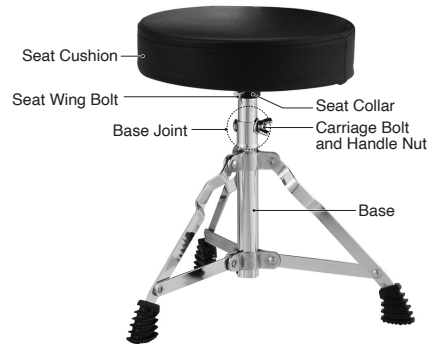

Fig. 21

### Note

Make sure that the Carriage Bolt is firmly seated in the base joint, and then tighten the handle nut.

## Basic Tuning

Here is the basic tuning method using the snare drum as an example. Gradually tighten the tension bolts diagonally as shown to raise the overall pitch of the head. Tap the head at each tension rod near the rim as shown below and listen to the pitches.

Adjust the tuning as needed to achieve uniform pitch all around the head. Most drummers tune the bottom head of the snare drum slightly higher than the top.

Basically, the tom toms and bass drum are tuned the same way as the snare drum. However, there are three ways to tune the top and bottom heads: tune both heads to the same pitch, tune the bottom head tighter than the top, or tune the bottom head looser than the top. Experiment to find the tuning method that works best for you (Fig.22).

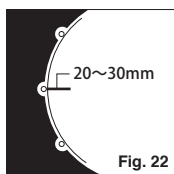
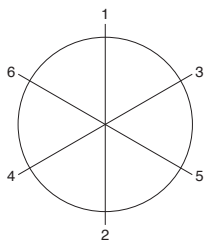

Fig. 22

Tuning Point

California Proposition 65



**Pearl**<sup>®</sup>

<https://pearldrums.com>

Products and specifications are subject to change without notice.

Printed in China

-2204-