

Pearl[®]

2022

GENERAL CATALOG





INSPIRATION AWAITS!

For over 75 years, Pearl's sound sculpting drum set options have given countless drummers their defining voice. Our lineup of premium percussion instruments has a fit for practically any playing style and budget. Our comprehensive Warranty promise lets you play with unparalleled confidence.

No matter where the drumming road takes you, Pearl has you covered - so explore, discover, and prepare to be inspired.



MASTERWORKS

A custom made heirloom instrument tailored to your exacting specifications.

SHELL RECIPE: Choice/Combination of Birch, Maple, Gum, and/or Mahogany.
SOUND: Your dreams. It literally sounds like the drum set of your dreams.

p. 2 - 9



REFERENCE

Made with premium Masterworks materials and individually engineered for articulate power and projection.

SHELL RECIPE: Reference Recipe Birch, Maple, and Mahogany hybrid.
SOUND: Built to fill arenas. Enhanced projection with cutting highs and powerful lows.

p. 10 - 11



PRESIDENT SERIES DELUXE

The darkly, dry "MJ" sound with classically controlled tonality.

SHELL RECIPE: 6-ply, 7.5mm Lauan.

SOUND: A slick locomotive of subdued, vintage punch with singular low-range overtone.

p. 28 - 29



CRYSTAL BEAT

The original seamless Acrylic drum shell creates a striking visual and sonic showcase.

SHELL RECIPE: 7mm Seamless Molded Acrylic.

SOUND: Loud and immediate, delivers pummeling straight tone and yielding feel.

p. 30 - 31



DECADE MAPLE

An upscale playing experience for the rising drummer, with prime lacquered shells and pro level elements.

SHELL RECIPE: EvenPly-Six, 5.4mm Maple.

SOUND: Full Maple tone with lively midrange and smooth sustain.

p. 32 - 33



REFERENCE PURE

Reference Recipe shell engineering in a lighter format for increased body and sustain.

SHELL RECIPE: EvenPly Birch, Maple, and Mahogany hybrid.

SOUND: Expressive, open tonality with responsive bottom-end boost.

p. 12 - 13



MUSIC CITY CUSTOM

Hand assembled in the USA for true Pearl Artists... Like you.

SHELL RECIPE: Choose From Four Premium SST Shell/Hardware Recipes.

SOUND: RF vast projection, RFP near field vibe, MRV classic tones, or MMG studio proven sound.

p. 14 - 19



MASTERS MAPLE RESERVE

The vintage flair of the original Masters sound for a refined playing experience.

SHELL RECIPE: 4-ply Maple w/ 4-ply Reinforcement Rings.

SOUND: Balance of powerful midrange and smooth resonant attack.

p. 20 - 21



EXPORT / EXPORT LACQUER

The Best Selling Drum Set of All Time gives the student drummer a strong beginning.

SHELL RECIPE: 6-Ply 7.5mm Poplar/Asian Mahogany Blend

SOUND: Crisp attack with dark, formidable bottom-end vibrance.

p. 34 - 35



MIDTOWN

An ultra portable shell pack for full sized play and powerful grooves in a small footprint.

SHELL RECIPE: 6-ply 7.5mm Poplar.

SOUND: Tight, responsive tonal bite with enough bottom to fill the pocket.

p. 36



ROADSHOW

A drum set package complete with everything needed to kickstart your rhythmic journey.

SHELL RECIPE: 9-ply 7mm Poplar.

SOUND: Piercing, open cut with full sub-bass rumble.

p. 37



MASTERS MAPLE/GUM

Optimized for the recording studio. Vital tone derived from the Masterworks: Studio shell recipe.

SHELL RECIPE: EvenPly-Six Maple (4-ply outer) and Gum (2-ply inner).

SOUND: Explosive midrange tonality with full low-end and precise decay.

p. 22 - 23



MASTERS MAPLE COMPLETE

Professional gear for independent touring. A sonic powerhouse with inspired custom appointments.

SHELL RECIPE: EvenPly-Six, 5.4mm North American Maple.

SOUND: Booming projection with equalized Low/Mid/High frequency mix.

p. 24 - 25



SESSION STUDIO SELECT

Radically unique from Stage to Studio. Blends pre-EQ'd warmth and articulate punch.

SHELL RECIPE: EvenPly-Six Birch (4-ply outer), African Mahogany (2-ply inner).

SOUND: Deep, rich bass frequencies. Top-end tonal spike.

p. 26 - 27

2022 GENERAL CATALOG

DRUM SETS	SNARE DRUMS	HARDWARE	PERCUSSION
2-9 Masterworks	38-39 MCC Solid Shell	56 Demon Drive	74 Percussion Artists
10-11 Reference	40-42 Series Component	57 Demon Chain	75 Signature Series
12-13 Reference Pure	43 Free Floating	58-59 Eliminator Redline	76-77 Congas & Bongos
14-19 Music City Custom	44 SensiTone Heritage Alloy	60-61 Eliminator Solo	78-79 Travel (Congas, Bongos, Timbales)
20-21 Masters Maple Reserve	45-47 Signature	62-63 P930 / P932	78 Timbales
22-23 Masters Maple/Gum	48-49 Hybrid Exotic	63 P530 / P830	79 Cowbells
24-25 Masters Maple Complete	48 DuoLuxe	64-65 Hi-Hat Stands	80 Djembes
26-27 Session Studio Select	49 StaveCraft	66 Snare Stands	81 Folkloric / Brazilian
28-29 President Series Deluxe	50 Modern Utility	67 Drum Thrones	82-83 Cajons & Accessories
30-31 Crystal Beat	51 Utility & Effects	68-69 Cymbal Stands	84 Handpans
32-33 Decade Maple		70-71 Racks	85 Tongue Drums
34-35 Export / Export Lacquer		72 Rack Accessories	86 Rainsticks / Nut Shakers
36 Midtown	52-53 e/MERGE	73 Tom Stands	87 Concert Percussion
36 Rocket Toms	54 MIMIC PRO	73 Tom Arms	88-89 Hand Percussion
36 Compact Traveler	55 malletSTATION		90 Percussion Stands
37 Roadshow / Jr.			91 Bags, & Holders
92-95 Replacement Parts	96-99 Pearl Artists	100-BACK Config. & Color Chart	101 Warranty Info

MASTERWORKS

Handcrafted To Inspire



IMAGINE...

...owning the drum set you've always dreamed of playing. A totally custom-tailored expression of your musical identity, crafted with heirloom precision to elevate your drumming persona.



“When I heard the Studio Recipe and the Maple/Gum shells, I sort of realized this might be a better tool for my situation, because I have to live in both a studio world and a live environment simultaneously. This Masterworks kit allows me to do that.”

NATE MORTON
The Voice

NATE MORTON'S "VOICE SEASON 23"
MASTERWORKS SONIC SELECT STUDIO RECIPE KIT
IN LIME/MINT/ICE SPARKLE LACQUER FINISH W/ CHROME HARDWARE



MASTERWORKS

Completely Custom, Totally Handmade

DRUMMING WITHOUT LIMITS

A Masterworks drum set is a timeless expression; custom tailored with heirloom precision to elevate your drumming persona, and fully reflect your musical identity.

THE MASTERWORKS DIFFERENCE

Selecting the right combination of our finest hand selected shell veneers with the precision engineering of our premium hardware appointments, Masterworks gives you the freedom to customize a sound that is completely your own.



HARDWARE FINISH, LUG, AND HOOP OPTIONS

A choice of five plating options comes standard on your selection of our precision tuning lugs, hoops, and drum hardware.

FINISHES



CHROME
(Shown w/
CL100 Lug)

NICKEL
(Shown w/
STL100 Lug)

GOLD
(Shown w/
STL150 Lug)

BLACK CHROME
(Shown w/
BRL100 Lug)

BLACK NICKEL
(Shown w/
STL150 Lug)

HOOPS

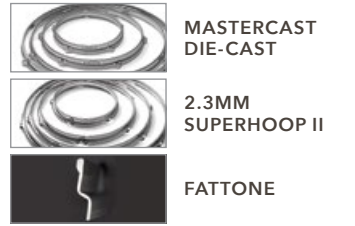

MASTERCAST DIE-CAST

2.3MM SUPERHOOP II

FATTONE

LUGS

- Bridge (CL100)
- Swivel Tube (STL150)
- Single Swivel (STL100)
- Swivel Arch (BRL100)

DRUM SHELL TONE WOODS

Choose one or a combination of our premium shell materials to sculpt the sound of each drum.

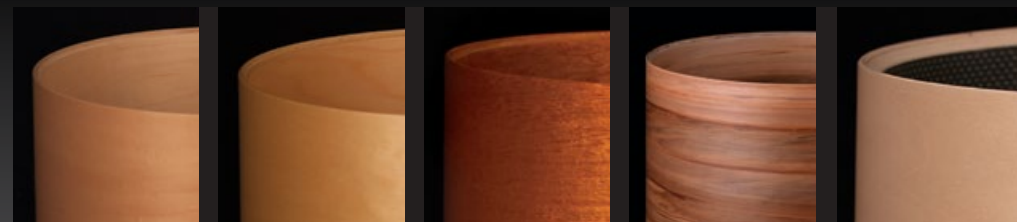

MAPLE
Tonally equal in highs, mids, and lows for prime, full bodied attack and sustain.

BIRCH
Boosted attack with "Built-in EQ" for articulate and evenly reduced decay.

AFRICAN MAHOGANY
Dark, elegant tone with powerful bottom-end emphasis.

GUMWOOD
As a core or interior ply, Gum enhances tone in surrounding plies.

CUSTOM INTERIOR
Choose any of Pearl's Artisan Exotic veneers, carbon fiber, or hand applied fiberglass for boutique tones and visuals.

SHELL SIZE AND THICKNESS

For precise tonal character, sustain, and projection.



THIN (4-ply, 5mm w/ 4-ply Reinforcement Rings) Increased sustain and low-end.

MEDIUM (EvenPly-Six, 5.4mm) Expanded tonal purity and resonant punch.

STANDARD (6-ply, 7.5mm) Full-bodied tonal projection ideal for general purpose.

THICK (8-ply, 10mm and 10-ply, 12.5mm) Maximum projection and quick decay.

FINISHES

Craft an inspired visual statement with drums hand finished and configured to your specifications.

- LUXURY**
Includes a choice of High Gloss, Satin Stain, and Sparkle Lacquer.
- CUSTOM**
Includes Pinstriping, Banding, Artisan II Custom Graphics.
- ARTISAN**
Choose from a selection of Exotic veneers (below) or hand applied Carbonply.



CAMEROON BLACK LIMBA

FLAME MAPLE

AFRICAN ZEBRA WOOD

TAMO ASH

WATERFALL BUBINGA

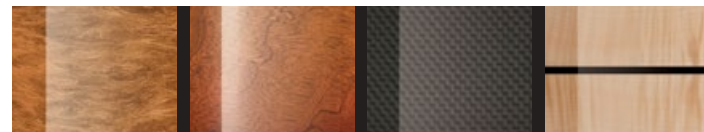

EUCALYPTUS

BURL MAHOGANY

CARBONPLY

SYCAMORE w/ EBONY INLAY*

*Ebony Inlay available on all Masterworks finishes

BEARING EDGE

Masterworks offers a choice of five sonically tested edges - configurable by drum, application, and shell side.



STANDARD 45°
Provides the perfect blend of attack and warmth.

OUTER 60°
Pulls brighter overtones and increases punch.

INNER 45° Edge apex focused to inner shell plies for controlled sustain.

ROUNDED 45° Increased head-to-shell contact boosts mids and highs.

FULLY ROUNDED
Boosts mid-to-low range response and reduces decay.



MASTERWORKS SONIC-SELECT STADIUM RECIPE
SHELLS WITH ARTISAN FLAME MAPLE AMBER EXOTIC GLOSS FINISH AND CHROME HARDWARE

WHAT'S INSIDE

Discover the elements of superior drum tone.

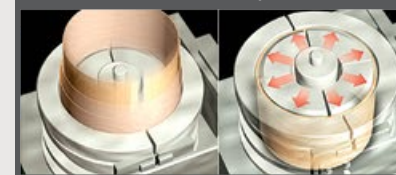

THE DIFFERENCE - The Ultimate in Strength, Resonance, and Tone.

Using the world's first high temperature hydraulic curing system, the SST method was developed to craft a multi-ply, bonded drum shell with single-ply resonance and strength.

All shells are formed in a bonded combination of cross-laminated 2-ply veneer panels; precision milled with overlapping scarf joint seams and cured with our exclusive AcoustiGlue at 1000 PSI of hydraulic pressure.

MASTERWORKS

Sonic-Select Shell Recipe

CUSTOMIZED TO FIT YOUR CREATIVE VISION

Like a blank canvas for your drumming ideal, modify any Sonic-Select Shell Recipe shell or hardware option to give it your own spin or use our exclusive Artisan II process to embed your choice of high definition graphics directly onto the outer shell.



CHOOSE YOUR ARENA. CREATE YOUR DREAM. DEFINE YOUR SOUND.
Our Sonic-Select Shell Recipes narrow the nearly endless scope of Masterworks choices down to five sonically proven shell and hardware combinations.

STUDIO
Explosive tonal clarity and articulation for recording.
pg. 6

URBAN
A thin, powerful blend for the precise metropolitan drummer.
pg. 7

STADIUM
Pearl's thick CZX Maple shell for high-volume power.
pg. 8 - 9

HERITAGE
Classic drum feel with enhanced lows and fat top-end slap.
pg. 8

MODERN DRY
Quick, top-heavy articulation with controlled low-end.
pg. 9

STUDIO



MASTERWORKS SONIC-SELECT STUDIO RECIPE SHELLS WITH ARTISAN BLACK LIMBA-BURST EXOTIC GLOSS FINISH AND CHROME HARDWARE

URBAN



MASTERWORKS SONIC-SELECT URBAN RECIPE SHELLS WITH ARTISAN BLACK LIMBA BLUEBURST EXOTIC GLOSS FINISH AND BLACK CHROME HARDWARE

STUDIO

- SHELL** EvenPly-Six (5.4mm), 4-ply Maple Outer with 2-ply Gumwood Inner
- BEARING EDGE** Outer 60° Gives increased power and bite to a thinner hybrid shell
- HOOPS** MasterCast Hoops
- LUGS** CL Bridge Lug
- CL100 (Toms)
- CL250 (Bass Drum)
- SPURS** SP300 w/ Retractable Spike
- FT BRACKETS** LB200

A POWERFUL SONIC FOUNDATION TUNED FOR THE RECORDING ENVIRONMENT.

This commanding shell/edge combination of hard exterior and milder tone woods yields explosive midrange projection and extended low end punch.

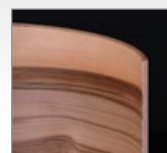

SHELL
Thin, resonant combination of a hard exterior with milder tonewood for explosive low-range warmth.



HOOPS
MasterCast Hoops. Escalates weight for tonal body. Increases volume in high velocity play.



BEARING EDGE
Outer 60° Gives increased power and bite to a thinner hybrid shell.



LUGS
CL Bridge Lug. A classic look with minimal shell contact for precise vibration control.

URBAN

- SHELL** EvenPly-Six (5.4mm Toms/Bass) 2-Birch/2-Gumwood/2-Birch with 4-ply Maple Re-Rings
- 8-ply Snare Drums
- 2 Birch/4 Gumwood/2 Birch
- BEARING EDGE** Rounded 45° on Toms
- Fully Rounded edge on bass drums
- Standard 45° on snare drums
- 2.3mm SuperHoop II*
- STL Swivel Tube Lugs*
- STL150* (Toms)
- STL300* (Bass Drum)
- SP300 w/ Retractable Spike
- FT BRACKETS** LB200

A FRESH SONIC DRUM BLEND FOR THE METROPOLITAN PLAYER.

From sold out tours to sanctuary halls, the tonal dichotomy of three proven hardwoods projects with a defiant top end and fills the bass frequencies with thunderous, shaking lows.

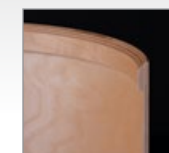

SHELL
Dense, thin shell hybrid for precise punch and quick, even decay.



HOOPS
2.3mm SuperHoop II Hoops - Made for heavy play without limiting tuning range performance.



BEARING EDGE
Rounded 45° on Toms (Fully Rounded edge on bass drums, Standard 45° on snare drums).



LUGS
A medium-weight lug with pivoting tension casing for increased projection and reduced overtone. STL150 / 300

*Recommended

MASTERWORKS



**MASTERWORKS:
COMPLETELY CUSTOM,
TOTALLY YOU**

Sonic-Select Shell Recipe



STADIUM

SHELL 10-ply Maple BD, 10-ply Maple FT, 8-ply Maple Toms and Snares
BEARING EDGE Outer 60° For increased power and controlled overtone
HOOPS 2.3mm SuperHoop II*
LUGS Swivel Bridge Lugs to maintain attack and tuning integrity. BRL100* (Toms) BRL300* (BD)
SPURS SP300 w/ Retractable Spike
FT BRACKETS LB200

* Recommended

THE CZX SOLUTION FOR HIGH VOLUME, RHYTHMIC COMMAND.

Pearl's legendary high density CZX Maple shell is reborn! Our classic 10-ply / 8-ply shell combination delivers penetrating volume, articulate midrange attack, and focused low end.

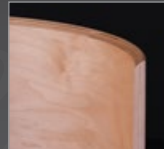

SHELL
A thick shell for dominating volume and articulate attack.



BEARING EDGE
Outer 60° Increases brightness and power with controlled overtone.



HOOPS
2.3mm SuperHoop II Hoops - Made to withstand heavy play while allowing the shell to breathe.



LUGS
Heavier weight increases attack and assures the ultimate in tuning integrity.

STADIUM



MASTERWORKS SONIC-SELECT STADIUM
RECIPE SHELLS WITH ARCTIC GLOSS WHITE LACQUER OVER CARBONPLY INNER/OUTER AND BLACK CHROME HARDWARE

19" CUSTOM AUTO RIM COURTESY OF AUTO CENTER INC., NASHVILLE, TN

HERITAGE

TIMELESS, ORGANIC TONE WITH SMOOTH LOW-END GROWL

The Heritage Recipe's robust blend of reinforced Maple/ Mahogany delivers solid midrange punch with exceptional sustain and thunderous sub bass frequencies.

HERITAGE

SHELL 4-ply Maple (2-ply outer) Mahogany (2-ply inner) w/ 4-ply Maple Re-Rings
BEARING EDGE Standard 45° Low contact edge for added projection and resonance
HOOPS 1.6mm FatTone*
LUGS STL100* (Toms) STL200* (Bass Drum)
SPURS SP300 w/ Retractable Spike
FT BRACKETS LB200

* Recommended

MASTERWORKS SONIC-SELECT HERITAGE
RECIPE SHELLS WITH ARTISAN TAMO RUBY GLOSS LACQUER WITH NATURAL/BLACK RALLY STRIPES, AND BLACK NICKEL HARDWARE

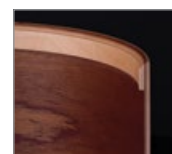

SHELL
A traditional blend of midrange punch and boosted low-end.



BEARING EDGE
Standard 45° - Precise, low-contact edge for added projection and resonance.



HARDWARE
FatTone Hoops - The light, rigid design of its exclusive hemmed edge increases resonance and tuning stability.



LUGS
Our lightest and most efficient tuning lug reduces hardware contact and weight on the shell.

MODERN DRY

DARKLY ORGANIC PUNCH FOR DRIVING, ORGANIC BEAT MAKING.

The Modern Dry Recipe blends three sonically unique tone woods for dark, controlled tone, and pillowy response. Its unique blend of shell and hardware elements adds bottom end focus and throaty punch.

MODERN DRY

SHELL 2-ply Maple outer/2-ply Gumwood inner with 4 ply Mahogany Re-Rings
BEARING EDGE Inner 45°
HOOPS MasterCast Hoops
LUGS Single Swivel Lugs
SPURS STL100 (Toms) STL200 (BD)
FT BRACKETS LB200

MASTERWORKS SONIC-SELECT MODERN DRY
RECIPE KIT IN SATIN AZURE FADE LACQUER FINISH OVER ARTISAN ZEBRAWOOD VENEER WITH GOLD-PLATED HARDWARE



SHELL
A unique blend of yielding tone woods and rigid exterior for added bottom-end focus.



BEARING EDGE
Inner 45° - Its inner shell apex contacts the head inside the shoulder for focused tunings in low tunings.



HOOPS
MasterCast Hoops - Gives each drum added weight for increased volume and controlled sustain.



LUGS
Single Swivel Lugs
Our lightest and most efficient tuning lug for reduced shell contact. STL100 / 200

REFERENCE

Sonically Select Drum Performance

Reference
SERIES DRUMS

DELIVERING OPTIMUM SOUND AND PROJECTION FOR THE POWER PLAYER

Utilizing the nearly limitless selection of materials and options from our Masterworks Custom Shop, each Reference tom, snare, and bass drum is individually optimized with its own shell, hardware, and edge "Recipe" to best capture its intended voice.

Just as single notes combine to make a piano, the total Reference kit's singular, unified voice perfectly captures every nuance of your unique drumming ideal.



#376 Ultra Blue Fade
RF943XP/C



#839 Red Burst Triband
RF923XSP/C

REFERENCE

SHELL Maple, Birch & African Mahogany
 SNARE 20 Ply Matching 13 x 6.5, 14 x 5 or 14 x 6.5*
 FINISH Super High Gloss Lacquer / Lacquer Sparkles
 HEADS Remo Clear Emperor Tom, Powerstroke3 Bass
 TOM MOUNTS Aluminum OptiMount Suspension System
 TOM ARMS Sold Separately
 HARDWARE Chrome (Standard)**
 HOOPS MasterCast Die-Cast Hoops
 LUGS BRL Bridge Lugs with Swivel Function
 *Sold Separately **Nickel, Black Chrome, Black Nickel, and Gold Hardware (Special Order)



MASTERCAST HOOP
 Enhance the overall weight and volume of each shell and stay true under constant play.

BRL SWIVEL LUGS
 Feature pivoting internal brass tension casings to assure tuning integrity and reduce shell stress.

SHELLS Individually engineered for power, tone, and distinction, the total Reference kit perfectly captures every nuance of your unique drumming identity with a singular, prestigious sound.



SP300 SPUR
 Pearl's SP300 bass drum spur features retractable high grip rubber tip and recessed spike for high impact, slip free play.

REFERENCE RECIPE	SHELL TYPE	BEARING EDGE	SONIC OUTPUT
8" and 10" Toms	Maple(4)/Birch(2) 6-ply (RF 7.5mm / RFP 5.4mm)	Rounded 45°	Cutting projection for high-note pitch
12" Toms	Maple(6) 6-ply (RF 7.5mm / RFP 5.4mm)	Rounded 45°	Transitional mid-note; blend of warmth and cut
13" Toms	Maple(4)/Mahogany(2) 6-ply (RF 7.5mm / RFP 5.4 mm)	Rounded 45°	Top-end slap with added low/bottom end
14" and 15" Toms	Maple(4)/Mahogany(2) 6-ply (RF 7.5mm / RFP 5.4 mm)	Fully Rounded	Bracing low-end with controlled punch
16" Toms	Maple(2)/Mahogany(4) 6-ply (RF 7.5mm / RFP 5.4mm)	Fully Rounded	Full, rounded sustain and gated attack
14" Floor Toms	Maple(4)/Mahogany(4) 8-ply (RF 10mm / RFP 7.2mm)	Fully Rounded	Fat, controlled low-end with smooth roll-off
16" and 18" Floor Toms	Maple(2)/Mahogany(6) 8-ply (RF 10mm / RFP 7.2mm)	Fully Rounded	Fat, controlled low-end with resonant warmth
18" and 20" Bass Drums	Maple(2)/Mahogany(4) 6-ply (RF 7.5mm / RFP 5.4mm)	Fully Rounded	Quick and Punchy with Powerful low-end
22" and 24" Bass Drums	Maple(2)/Mahogany(6) 8-ply (RF 10mm / RFP 7.2mm)	Fully Rounded	Booming bass tone with articulate punch

REFERENCE PURE

Unrestricted Tonal Response

Reference
PURE

THE EVENPLY DIFFERENCE lies in thinner shell layers. Using the same hybrid wood composition as the Reference Recipe with thinner plies gives the Reference Pure shell a lean profile with increased strength. Combining the ultra thin EvenPly shell with more efficient shell hardware reduces overall drum weight by 30% for increased resonance, improved bottom end, and a more nuanced near field playing experience.



#831 Matte Olive Burst
RFP924XEDP/BN**



#377 Scarlet Sparkle Burst
RFP924XSP/C

REFERENCE PURE

SHELL Low Mass EvenPly Maple, Birch & African Mahogany
 SNARE EvenPly-Six Matching 13 x 6.5, 14 x 5, 14 x 6.5*
 FINISH Super High Gloss Lacquer / Lacquer Sparkles
 HEADS Remo Clear Emperor Tom, Powerstroke3 Bass
 TOM MOUNTS Aluminum OptiMount Suspension System
 TOM ARMS Sold Separately
 HARDWARE Chrome (Standard)**
 HOOPS Low Mass FatTone Hoops
 LUGS Low Mass STL Swivel Tube Lugs

*Sold Separately **Nickel, Black Chrome, Black Nickel, and Gold Hardware (Special Order)
 Nickel (N), Gold (G) Black Chrome (B) Or Black Nickel (BN)
 Plated Hardware Available By Special Order For A Premium Charge

SHELLS

Boasting the same shell construction that made Reference drums a professional standard, Reference Pure's uninhibited, shell-focused tonality excels in any playing environment.



#119 Matte Black
RFP923XSP/BC
w/ RFP1414F/BC**



OPTIMOUNT
Aluminum Tom
Mounts suspend the
drum evenly across
four tension points to
allow resistance-free
resonance in play.



1.6MM FATTONE
HOOPS
Exclusive hemmed/welded
edge (U.S. Pat. #8367917)
gives increased strength to
low mass design.



STL SWIVEL
TUBE LUGS
Allow for increased
resonance, minimal shell
contact, and precisely
aligned, no bind tuning.



AIR SUSPENSION
RUBBER TIP
(U.S. Patent #5881981)
Isolates the tom from
the floor, preventing
tonal choke and
increasing resonance.

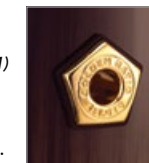

GOLDEN RATIO
AIR VENT
(U.S. Patent #7485791)
is precision placed in
the Fibonacci Spiral
on toms to increase
low-end response.



SNARE DRUMS

A thin EvenPly-Six shell with four outer Maple and two inner Birch plies for cut, projection, and smooth, balanced sound. 45° bearing edges provide superbly articulate sensitivity.

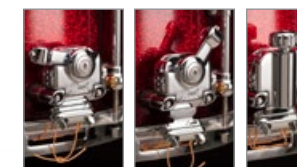

SR1000

SR1000 Glide-Lock Strainer's locking throw off lever and tension knob assures slip-free performance. (U.S. Patent #7220905, #7301087, #7365256)

MUSIC CITY CUSTOM

Hand Assembled In The USA
For True Pearl Artists... Like You



GET IT WHEN YOU NEED IT

Now in its seventh year, our Music City Custom program continues to deliver tour ready and customized drums to the player of distinction in unparalleled time. Crafted from one of Pearl's four professional grade Shell Recipes and hand assembled in Nashville, Tennessee, most orders are completed within 30 business days* in an extensive choice of sizes and finishes.

**30 Business days from the date we receive your order, restrictions apply, consult your Pearl dealer for details and availability.*



CHOOSE THE RECIPE THAT DEFINES YOUR SOUND.

MASTERS MAPLE GUM

(pg. 14-15) Vital, explosive tonality with precise low-end decay.

MASTERS MAPLE RESERVE

(pg. 16-17) Sonically-balanced attack with smooth midrange.

REFERENCE

(pg. 18) Maximum projection with powerful, formidable tone.

REFERENCE PURE

(pg. 19) Lively, resonant timbre with increased body and sustain.



#422 Matte White Marine Pearl (Large)

MUSIC CITY CUSTOM

Hand Assembled In The USA
For True Pearl Artists... Like You

A FOUR DECADE TRADITION OF ARTIST CRAFTSMANSHIP



#496 Platinum Smoke Marine



IT ALL STARTS WITH THE SHELLS.

With four SST ply formulas and the most popular size options to choose from, each shell is individually inspected for roundness and edge integrity before entering the finishing phase.

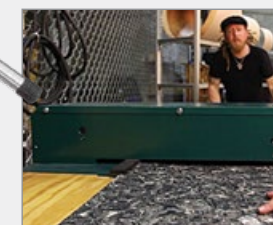

CHOOSE FROM 34 TOUR READY FINISHES.

Pearl's Music City Custom Shop keeps 35 different durable finishes in stock. All USA made by Delmar and hand applied with a time tempered precision.



CNC DRILLED TO PERFECTION.

Pearl's unique CNC routing process means that all hardware is precision placed for accurate tuning and function.



HAND ASSEMBLED AND INSPECTED.

Each Music City Custom drum is hand assembled for a uniquely refined playing and ownership experience.

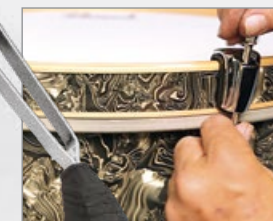

BUY IT ONCE, PLAY IT FOR LIFE.

Our goal is to complete each order within 30 business days from the date we receive it. Our final hand inspection certifies quality, our unbeatable Lifetime Warranty guarantees it.



MCC: MASTERS MAPLE RESERVE

Pearl's classic MRV 4-ply shell with 4-ply Re-Rings, FatTone hoops, and CL bridge lugs for balanced Maple tone.

ARTIST DESIGNED, HAND ASSEMBLED

Explore the option of four premium SST drum shell types; precision drilled to order, assembled, and immediately available in your choice of 34 tour ready finishes. From classic sparkles and vintage pearls to timeless favorites, it's here and ready to define your command of the stage.

Music City Custom provides the true artist experience and a drum set like no other. Quick custom manufacturing, massive size and finish selection, industry leading craftsmanship, and Pearl's exclusive Lifetime Warranty all combine to set a new standard for USA born, high end drum sets.

For over 40 years, our exclusive USA Artist Custom shop has collaborated with some of drumming's biggest names to handcraft their personal touring kits. Pearl now invites you to experience the same level of unparalleled service with Music City Custom.



Barry Kerch (Shinedown) and Dustin Steinke (SIXX:A.M.) backstage with their MCC kits.



Brian Frasier Moore (Justin Timberlake / Pink) on his MCC Reference Pure Drum Set.

PHOTO: JAMES ROBINSON

MUSIC CITY CUSTOM

Hand Assembled In The USA
For True Pearl Artists... Like You

34 IN-STOCK FINISHES

With a broad palette of visually radiant wrapped finishes, Music City Custom offers you 35 different Premium covering options from Delmar USA. From classic Sparkles and vintage Pearloids to Glass Glitters and Satins, it's all here and ready to inspire your drumming creativity.



MCC: REFERENCE
Maximum projection with powerful, formidable tone.



#424 Vintage Blue Sparkle



MCC: REFERENCE PURE
Lively, resonant timbre with increased body and sustain.



#420 Golden Yellow Abalone



MASTERS MAPLE RESERVE

A Classic Formula
for Sonic Greatness

THE MASTERS LEGACY

Derived from Pearl's original Masters shell recipe, Masters Maple Reserve Drums deliver a sophisticated, balanced tonal combination of powerful midrange and sustained resonant shimmer. Projecting vintage flair, centered sonic character, and rich, tonal balance, Masters Maple Reserve is truly something to be experienced.



***Nickel (N), Gold (G) Black Chrome (B) Or Black Nickel (BN)
Plated Hardware Available By Special Order For A Premium Charge

#839 Red Burst Triband
MRV943XP/G

MASTERS MAPLE RESERVE

- SHELL 4-ply (5mm) 100% Maple w/ 4-ply Maple Re-Rings
- SNARE Matching 14x5.5 or 14x6.5*
- FINISH Super High Gloss and Matte Lacquer**
- HEADS Coated/Ported Powerstroke3 Bass (Front)
Clear Powerstroke3 (Batter)
- TOM MOUNTS Aluminum OptiMount Suspension System
- HARDWARE Chrome***
- HOOPS Low Mass FatTone Hoops
- LUGS CL Bridge Lugs
- BD MUFFLER BDMF (Full Size)
*Sold Separately



#343 Olive Burst
MRV923SXP/C

SHELLS
4-ply Maple shell with 4-ply Maple Reinforcement Rings. A classic shell fusion delivering rich, sustained lows and controlled sonic punch.



Masters Maple Reserve is available in all 34 Music City Custom Special Order finishes - see Pages 18-19.
**Also available in 28 Special Order Lacquer finishes - see back cover.

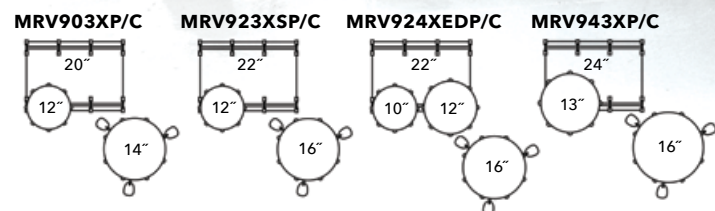

ALUMINUM OPTIMOUNT SUSPENSION SYSTEM
Light and efficient four-point contact design delivers secure tom mounting without penetrating the shell.

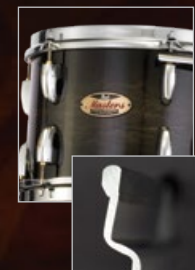

HARDWARE FatTone Hoops
- Rigid 1.6mm hemmed/welded edge extends sustain with punchy projection.



CL BRIDGE LUGS
A classic lug with a minimal contact arc for precise vibration control.

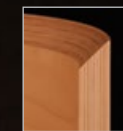

BEARING EDGE
Standard 45°



#850 Aqua Turquoise Stripe
MRV924XEDP/BN
w/ MRV1414F/BN & MRV1309T/BN

MASTERS MAPLE/GUM

The Evolution of
Premium Studio Tone

THE MASTERWORKS STUDIO RECIPE, SIMPLIFIED.

Delivering arguably the greatest drum tones ever recorded, Pearl's fresh take on the legendary Maple/Gum shell recipe reaches new levels in dynamic sonic warmth and explosive low-end response.

Now, Pearl expands Masters Maple/Gum with updated finish and component options; making our first production Masterworks kit a true prize for the owner.



#186 Hand Rubbed Natural Maple

#854 White Ice Swirl*

Masters Maple/Gum is available in all 34 Music City Custom Special Order finishes - see Pages 18-19.
**Also available in 28 Special Order Lacquer finishes - see back cover

*Shell Packs: Stock, Components: Special Order. Added components in #186 can be special ordered.

Masters
MAPLE/GUM

MASTERS MAPLE/GUM

SHELL	EvenPly Six (6-ply, 5.4mm) North American Maple/Gum
FINISH	Hand-Rubbed Natural Wax or Premium USA Wrap
HEADS	Remo Coated Ambassador, Powerstroke3 Bass
TOM MOUNTS	OptiMount Aluminum Suspension System
HARDWARE	Chrome
HOOPS	MasterCast Die-Cast
LUGS	CL Bridge Lugs



#854 White Ice Swirl
MMG924XSP/C w/ MMG1414F/C

SHELLS
EvenPly-Six, 4-ply Maple outer with 2-ply Gumwood inside - The natural warmth of Maple is enhanced by Gumwood's dense, controlling character.

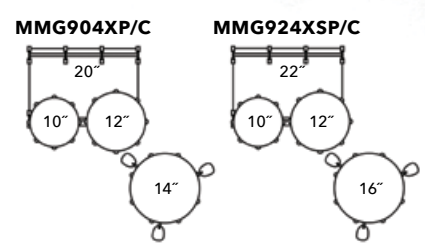

#842 Light Amber**
MMG924XSP/C w/ MMG1414F/C



**MASTERCAS
HOOPS**
Escalates weight for tonal body and increases volume in high velocity play.



BEARING EDGE
Outer 60° - Gives increased power and bite to a thinner hybrid shell.



CL BRIDGE LUGS
A classic look with minimal shell contact for precise vibration control. CL100 / 250

MASTERS MAPLE COMPLETE

An All Maple Drum Shell
Fit for the Masters Legacy

**UNPARALLELED SOUND.
ATTAINABLE PRICE.**

Fully loaded with all the elements that made Pearl's Masters Series a must for the touring drummer, Masters Maple Complete offers a tonally superior percussive statement for the road ready pro.

MASTERS MAPLE COMPLETE

SHELL	EvenPly Six (6-ply, 5.4mm) 100% Maple
SNARE	Matching 14x5.5 or 14x6.5*
FINISH	Super High Gloss Lacquer or Premium USA Wraps
HEADS	Remo UT Pinstripe Tom, Ported UT Powerstroke3 Bass
TOM MOUNTS	OptiMount Suspension System
HARDWARE	Chrome
HOOPS	SuperHoop II
LUGS	2.3mm Triple Flanged CL Bridge Lugs

*Sold Separately



#448 White Marine Pearl
MCT903XP/C

SHELLS
EvenPly-Six (5.4mm) North American Maple - Fuses reduced thickness, cross laminated ply panels for expanded tonal purity and increased resonance.



Five premium finishes are available in four preconfigured shell packs, as well as a host of component and add-on drums.

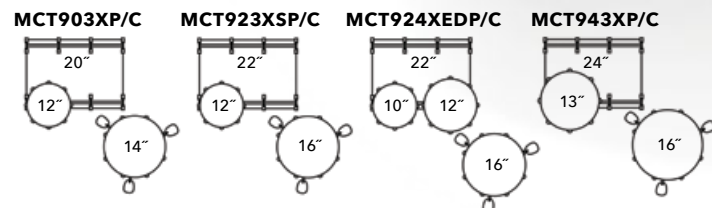

BEARING EDGE
Standard 45° - Pearl's original precision edge adds sustain through reduced shell-to-head contact.

CL BRIDGE LUGS
A classic look with minimal shell contact at separate points for precise vibration control.

HARDWARE
2.3mm SuperHoop II Hoops - Made to maintain tuning integrity in heavy play while delivering maximum shell resonance.

#837 Chrome Contrail
MCT924XEDP/C

Masters
MAPLE COMPLETE

SESSION STUDIO SELECT

A Completely New Take
on the Full Spectrum Sound

SESSION STUDIO SELECT

A TRUE PEARL ORIGINAL, WITH
A FRESH, GROOVE INSPIRING VIBE.

Taking a tip from the Masterworks spectrum, Session Studio Select's unparalleled combination of Masters-grade Birch and African Mahogany deliver a refined standout for recording and gigging.



#852 Black Satin Ash
STS925XSP/C



BEARING EDGE
Outer 60-Degree.
Increases volume and punch without harsh overtones.



HARDWARE
SuperHoop II, 2.3mm Triple-Flanged hoops for rigid tuning stability without robbing the shell of sustain.

HIGH GLOSS & SATIN LACQUER

- #112 Natural Birch
- #314 Gloss Barnwood Brown
- #315 Antique Crimson Burst
- #852 Black Satin Ash

PREMIUM DELMAR WRAP

- #405 Nicotine White Marine Pearl (Large)
- #414 Ice Blue Oyster

#405 Nicotine White Marine Pearl
STS925XSP/C w/ added 8x7 Tom and
20x14 Gong Drum

SHELLS
EvenPly-Six Birch/African Mahogany. A unique sonic dichotomy of piercing projection, smooth low-end and pre-EQ'd punch.



SESSION STUDIO SELECT
SHELL EvenPly-Six (6-ply, 5.4mm) Birch/African Mahogany
SNARE 14x5.5, 14x6.5, or 14x8 Matching Wood*
FINISH Premium Wrapped or High Gloss Lacquer
HEADS Remo Pinstripe Clear Tom, Powerstroke3 Bass, UT Coated Snare
TOM MOUNTS OptiMount Suspension System
TOM ARMS Sold Separately
HARDWARE Chrome
HOOPS SuperHoop II 2.3mm Triple Flanged
LUGS RL Lugs
**Sold Separately*

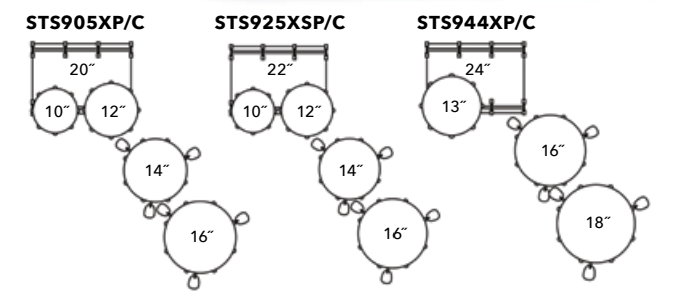

PRESIDENT SERIES DELUXE

A Modern Revival of The Darkly Unique Lauan Sound



BEARING EDGE
Rounded 45° - Increased head-to-shell contact boosts mids and highs and helps control overtone spread.



HARDWARE
2.3mm SuperHoop II Hoops - Made to maintain tuning integrity in heavy play while delivering maximum shell resonance.



BSL LUGS
Cast in 1969 as "C043" for Pearl's professional outfits, it has since been dubbed "The Battleship Lug" by collectors for its angular profile. The new BSL100 features the same striking look and self-aligning design with a more robust casting for better tuning integrity.



#768 Desert Ripple
PSD943XP/C

Drawing from the very origins of Pearl's drum manufacturing history, President Deluxe Series revives the warm subtlety of our original tone wood for a traditionally full, controlled playing experience.



#450 Silver Sparkle #767 Ocean Ripple #768 Desert Ripple

DELIVERING A DISTINCTLY CLASSIC PLAYER'S GROOVE.

A modern take on a familiar favorite, President Series Deluxe drums revive our original 6-ply Lauan shell, the source of the original "MIJ" (Made in Japan) sound. This darker toned medium/hardwood was the basis of thousands of shells made by Mitsuo Yanagisawa in Pearl's Chiba, Japan-based drum factory starting in 1961.

Presenting prime vintage style without the shortcomings of yesterday's fittings, President Series Deluxe features a recasting of our classic "Battleship" lug and adjustable tone mufflers on each drum. The elegant identity of Pearl's original script badge and classic bass drum logo augment the swirling flash of a choice of our Ripple covered finishes.

Each President Series Deluxe drum kit comes standard with Remo CS "Black Dot" UT heads, classic felt bass drum muffling strip, shell-mounted cymbal holder, and adjustable "Gullwing" style bass drum spurs.



#767 Ocean Ripple
PSD0810P/C



Single-braced stand included.

#450 Silver Sparkle
PSD923XP/C
w/ added 14"x10", 12"x8", and 10"x7" Toms, 18"x16" and 14"x14" Floor Toms, and PSD0810P/C Double Tom Set

SINGLE-HEADED CONCERT TOM SET
A period-correct companion to President Series Deluxe shell packs. Includes 8"x6" and 10"x7" single headed toms with Traditional Slide/Clip mounts.

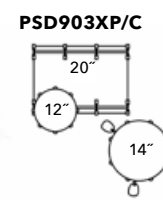

PSD903XP/C

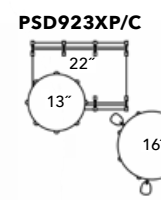

PSD923XP/C

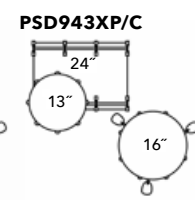

PSD943XP/C



SHELLS
6-ply 7.5mm Lauan. Loud yet subdued with deep, punchy wallop and plenty of top-end attack.



PRESIDENT SERIES DELUXE

- SHELL 6-ply 7.5mm Lauan
- SNARE 14" x 5.5"
- FINISH Premium USA Ripple Coverings
Remo UT CS Black Dot Batters
Anniversary Ed. Smooth White Coated Ambassador w/ Classic Pearl Logo
- HEADS BSP835 "Gullwing" Style
- SPURS CHB75LB
- BD CYMBAL MOUNT CHB75LB
- HOOPS SuperHoop II 2.3mm Triple-Flanged
- LUGS BSL100/BSL200/BSL55
- BD MUFFLER BDMF and Resonant Felt Strip

*Sold Separately

CRYSTAL BEAT



Originating in 1973, Pearl's Crystal Beat Acrylic drums feature a 7mm molded/seamless Acrylic shell for a vivid combination of cutting tonal power and stunning visual appeal.

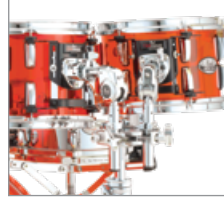

HARDWARE
Toms include the OptiMount suspension system for increased sustain and 1.6mm triple-flanged hoops for attack and punchy tonal body.

The Original Seamless Acrylic Drum Shell



#732 Tangerine Glass
CRB543P/C



#731 Ruby Red
CRB503P/C



SHELLS
Loud and immediate, delivers pummeling straight tone and yielding feel. Dual 45° bearing edge with a rounded apex, adding control and increased articulation to acrylic's sonic signature.

CRYSTAL BEAT

- SHELL 6mm (7mm on Bass Drums) Seamless Molded Acrylic
- SNARE Matching Free Floater*
- FINISH Transparent
- HEADS Transparent 2-Ply on Tom Batters Single-Ply Resonant
- TOM MOUNTS OptiMount Suspension System
- TOM ARMS Sold Separately
- HARDWARE Chrome
- HOOPS Chrome 1.6mm Triple-Flanged
- LUGS CB Mid-Lugs on Toms, CB Fat-Lugs on Bass

*Sold Separately

CRB524P/C CRB524FP/C CRB525FP/C CRB503P/C CRB543P/C

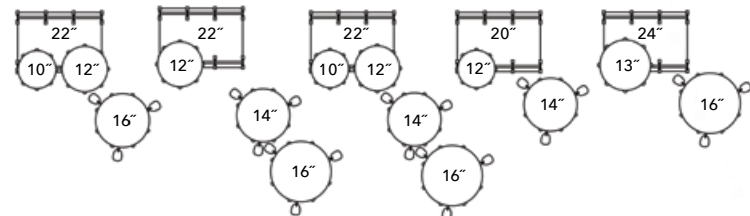

Individual components also available. For sizes, visit www.pearldrums.com



CRYSTAL BEAT



#730 Ultra Clear

DECADE MAPLE

A Drum Kit 10 Years in the Making



#216 Kobalt Blue Fade
DMP943XP/C

DECADE MAPLE

BUILT TO PUSH THE BOUNDARIES OF PERFORMANCE AND PRICE

Decade Maple Series drums elevate the playing field for the advancing drummer with pro features and unbeatable value.

DECADE MAPLE

SHELL	EvenPly-Six (5.4mm) 100% Maple
SNARE	Matching 14x5.5
FINISH	High-Gloss / Matte Lacquer
HEADS	Remo UT Clear Ambassador Tom, Ported UT Powerstroke3 Bass
TOM MOUNTS	Opti-Loc Mounting System
HARDWARE	Chrome
HOOPS	1.6mm Steel Triple Flanged
LUGS	NDL Lugs
BD MUFFLER	BDMM (Mini)



OPTI-LOC MOUNTING SYSTEM
This three-point isolation mount suspends the drum at two tuning points and one of the drum's air vents for solid, stable play.



HARDWARE
• Uni-Lock gearless Tom Arms.
• R40 Air Suspension Floor Tom feet.
• NDL Mini Lugs: For reliable, rock solid durability and sound.



#261 Gloss Deep Red Burst
DMP905P/C



#262 Satin Black Burst
DMP927SP/C

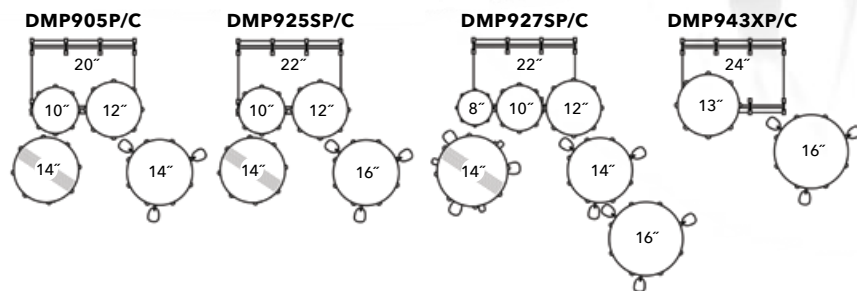

SHELLS
6-ply/5.4mm Maple - Thin (but powerfully strong) Pearl's SST shell reacts quickly to the stroke with beautifully resonant highs and thundering lows.



EXPORT LACQUER

The Legends of Tomorrow, Play Export Today

EXPORT

The Best Selling Drum Set of All Time



The Export Series 30 year pedigree of unbeatable quality and value shines on with Reference-inspired shell woods and high impact hardware, giving the rising player a truly high end playing platform.



Export Series drums are available in three preconfigured packages with our robust 830 Series hardware; and feature a choice of gorgeous lacquer (EXL) or durable wrapped (EXX) finishes.



EXPORT LACQUER

- SHELL 6 Ply 7.5mm Birch/Poplar & Asian Mahogany Blend
- SNARE 14 x 5.5 Matching Wood Snare
- FINISH Choice of 4 High Gloss Lacquer Finishes and 1 Satin Finish
- HEADS Remo Clear Tom Head, Powerstroke Bass Head
- TOM MOUNTS Opti-Loc Mounting System
- TOM ARMS TH70I
- DRUM TH70I
- HARDWARE Chrome
- HARDWARE P930, BC830, C830, H830, S830
- BD MUFFLER BDMM (Mini)



* Available by special order only

#246 Natural Cherry
EXL725/C

#31 Jet Black
EXX725/C + EXX8P/C



830 SERIES HARDWARE
Sophisticated, sturdy, and efficient, Export's 830 Series Boom (BC830), Cymbal (C830), and Snare (S830) stands all feature gearless Uni-Lock Tilters for pinpoint positioning, and robust double-braced tripods for secure stability in play. The H830 Hi-Hat stand also features swivel legs that accommodate double pedals.



Drum Pedal
P930

P930 PEDAL
Featuring the longboard styling and feel of Pearl's Demon Drive pedal, the P930 offers two chain drive cam options for power, speed, and control.

OPTI-LOC MOUNTING SYSTEM

Pearl's three way tom mount delivers wobble free stability by suspending the drum at two tuning points and one of the drum's two air vents.



EXPORT

- SHELL 6-Ply 7.5mm Poplar/Asian Mahogany Blend
- SNARE 14 x 5.5 Matching Wood Snare
- FINISH Choice of 6 Covered Finishes
- HEADS Remo Clear Tom Head, Powerstroke Bass Head
- TOM MOUNTS Opti-Loc Mounting System
- TOM ARMS TH70I
- DRUM TH70I
- HARDWARE Chrome
- HARDWARE P930, BC830, C830, H830, S830
- BD MUFFLER BDMM (Mini)

SHELLS

6-ply/7.5mm Poplar/Asian Mahogany. A Pearl SST (Superior Shell Technology) blend for high volume resonance and sustained low-end punch.

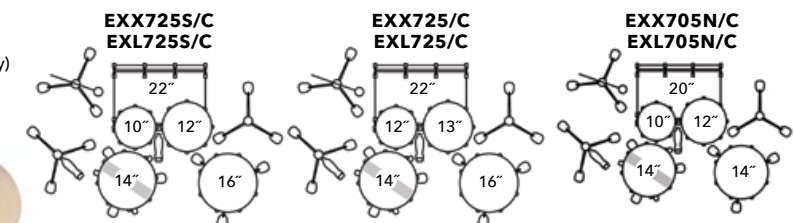

INCLUDES HWP830 HARDWARE PACK

MIDTOWN

Big Gig, Small Rig, Huge Sound

SETTING THE PULSE FOR THE METROPOLITAN GROOVE

Pearl's ultra portable Midtown Kit is the perfect sounding board for full size sound and play in a smaller footprint. Ideal for tight giggering spaces on a budget.

MDT764P/C

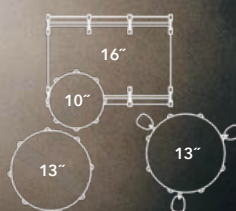

MIDTOWN

- SHELL 6 Ply (7.5 mm) Poplar
- SNARE Matching 13x5.5 Wood Snare Drum
- FINISH Choice of 3 Covered Finishes
- HEADS Remo UC Clear Tom, Remo UC Clear Powerstroke Batter Bass
- TOM ARMS TH701
- HARDWARE Chrome

SHELLS
6 Ply (7.5 mm) Poplar. Quick and biting attack with lively overtones.

INSTANTLY PORTABLE
The Midtown Kit's compact size quickly breaks down into two optional gig bags (**PMTBG**) for quick transport.

#33 Pure White
MDT764P/C

Lift used on Midtown raises the drum to the optimal position for your pedal.

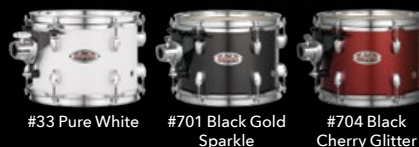

#33 Pure White #701 Black Gold Sparkle #704 Black Cherry Glitter

ROCKET TOMS

For striking staccato tone that's both melodic and piercing, Pearl's Rocket Toms are 6" pitched toms in varying lengths made to expand the sonic palette of any drum kit.

Available in sets or as individual components in Aluminum. Finishes: #103 Piano Black, #109 Arctic White, or #730 Ultra Clear Acrylic.



- AL0612 6" x 12"
- AL0615 6" x 15"
- AL0618 6" x 18"
- AL0621 6" x 21"
- ALX1215 6" x 12", 6" x 15" (w/ T890)
- ALX1821 6" x 18", 6" x 21" (w/ T890)
- CRB612/C 6" x 12" (Acrylic #730 Ultra Clear)
- CRB615/C 6" x 15" (Acrylic #730 Ultra Clear)
- CRB618/C 6" x 18" (Acrylic #730 Ultra Clear)
- CRB621/C 6" x 21" (Acrylic #730 Ultra Clear)

COMPACT TRAVELER

COMPACT TRAVELER

- BASS DRUM 18" w/ Base Frame & L-Arm Handle
- SNARE 10" w/ Adjustable Snare Rake
- STANDS Sold Separately
- CARRYING CASE PSCPCTK (Sold Separately)
- ADD ON PACK PCTK1014 Includes 10" & 14" Toms w/ Mounting Hardware

Take the rhythm on the road with Pearl's totally portable, super playable, ultra affordable beat maker. Perfect for School, Street, Practice, and Stage.



*HW/Cymbals sold separately

Pedal sold separately
PCTK1810

Add on pack (10" & 14" toms w/ mounting hardware)
PCTK1014

Optional Compact Traveler Bag
PSCPCTK

Optional Compact Traveler Add on Bag
PSCPCTKADD

ROADSHOW



It's Your Time to Play. Start the Right Way!

THE RHYTHM IS IN YOU

Drumming knows no age limit. Regardless of when your rhythmic journey starts, Pearl's Roadshow Series has a drum set package scaled for players of all ages that includes everything you need to get on the road to drumming greatness.

SHELLS
Featuring a 9 ply Poplar shell for optimum tonal power.



ROADSHOW

- SHELL 9 Ply 7mm Asian White Poplar
- SNARE Matching Wood Snare
- FINISH Choice of 5 Covered Finishes
- HEADS Clear Tom Heads, Coated Snare Head, Self-Muffled Locking 7/8" Tube Joint Holders
- TOM ARMS Individually Locking 7/8" Tube Joint Holders
- HARDWARE Dual-Chain Drive Bass Drum Pedal, Double-Braced Cymbal*, Snare and Hi-Hat Stands, Double-Braced Throne
- CYMBALS 16" Brass Cymbal, 14" Brass/Hybrid Hi-Hat Cymbals
- ACCESSORIES Pro Drum Stick Bag, Two pairs of Maple 5A Sticks

For additional info, testimonials, free assembly and instructional videos, and access to the largest drummer's community on the web, go to:

WWW.MYFIRSTDRUMSET.COM



#33 Pure White
RS525SC/C



#31 Jet Black #33 Pure White #91 Red Wine #703 Aqua Blue Glitter #706 Charcoal Metallic #707 Bronze Metallic

Complete Sets with Hardware, Cymbals, and Throne.

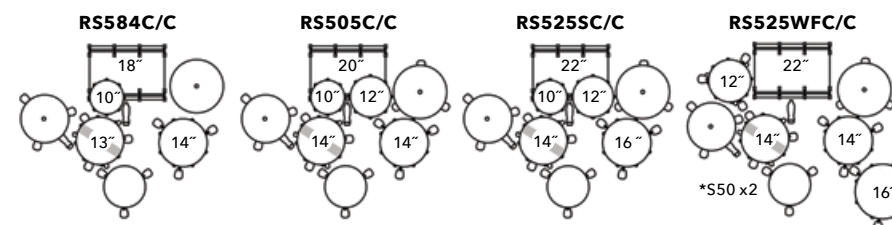

INCLUDES CH50/H50/S50*/P50/D50/16" CRASH/14" HI-HATS, STICK BAG, STICKS



#706 Charcoal Metallic
RS584C/C

ROADSHOW JR.

Pearl's Roadshow Jr. is NOT a toy. It's a serious, all-in-one, five piece drum set sized for kids under 8-years-old featuring hardware, cymbals, and sturdy White Poplar shell construction for an exceptionally powerful drumming start.

Complete with Hardware, Cymbals, and Throne for Drummers under 8.

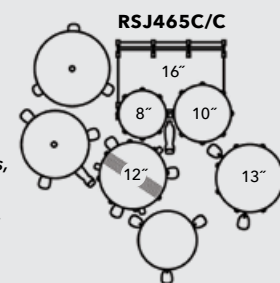

#31 Jet Black
RSJ465C/C

#708 Grindstone Sparkle
RSJ465C/C

Also available in
#33 Pure White

MUSIC CITY CUSTOM

Solid Shell Snare Drums
Handcrafted in the USA



DISCOVER THE SNARE DRUM YOU'VE BEEN WAITING FOR.

A singular tonal expression that elevates your approach to playing - and feeling - the drums.

Pearl's Music City Custom Solid Shell Snare Drums are uniquely refined, American made percussion instruments crafted with time honored precision. Using an old world technique derived from the shipbuilding trade, each solid shell is meticulously hand-formed from a steam treated plank of premium North American lumber.

Each Music City Custom Solid Shell Snare is then drilled with CNC precision before being hand finished and assembled by our Custom Shop team in Nashville, TN.

The natural beauty of each shell is further refined with a hand-rubbed oil finish available in a choice of standard Nashville Natural or with one of our exceptional, exotic inlay options. Pearl's Music City Custom Solid Shell Snare Drums are truly instruments elevated above all others.



Our handcrafted Solid Shell Snare Drums all feature Solid Maple Reinforcement Rings bonded to both top and bottom of the shell interior.

SOLID SHELL WOOD OPTIONS



SOLID MAPLE

The standard for premium, tonally centered midrange punch and restrained overtone.



SOLID CHERRY

Slightly brighter in tone than Maple with cutting projection. Best suited for a higher velocity stroke.



SOLID WALNUT

A fat growl with a naturally darker tone, the sound of Walnut is a perfect complement to its luxurious grain.



SOLID ASH

Brighter, louder, and with the crack of a homerun hit, the tonal quality of Ash is punchy with extended sustain.

MUSIC CITY CUSTOM

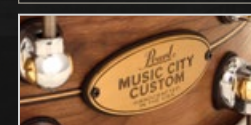

SHELL	8mm w/ 6mm Solid Maple Re-Rings
EDGE	Standard 45°
HOOPS	SuperHoop II Triple-Flanged
LUGS	STL100
RODS	Stainless Steel
STRAINER	SR017
SNARES	SN1420I

FINISH AND INLAY OPTIONS

Craft an instrument that truly demands your attention. Each Solid Shell Wood Option is available in your choice of hand rubbed Nashville Natural (without inlay) or configured with one of these exotic inlay options:

#1002
KINGWOOD ROYAL INLAY
(Shown on 14" x 6.5" Maple)
Centered Nicotine White Marine Pearl band surrounded by dual Kingwood inlay strips.
• Available only on 6.5" models



#1003
DUOBAND EBONY MARINE INLAY
(Shown on 14" x 6.5" Ash)
A White Nicotine Marine Pearl band surrounded by dual inlay strips of Macassar Ebony.
• Available only on 6.5" models



#1004
BOXWOOD-ROSE TRIBAND INLAY
(Shown on 14" x 6.5" Cherry)
Three thin bands of Artisan Rosewood and Boxwood creates a stunning inlay.
• Available only on 6.5" models



#1001
KINGWOOD CENTER INLAY
(Shown on 14" x 5" Maple)
A dark, dense inlay from the exotic Brazilian Rosewood family with a rich vertical grain.
• Available on all 5" & 6.5" models



#1005
NICOTINE WHITE MARINE INLAY
(Shown on 14" x 5" Maple)
Embeds a single 6mm band of White Nicotine Marine Pearl in the shell center.
• Available only on 5" models



#1006
BOXWOOD-ROSE SINGLE INLAY
(Shown on 14" x 5" Walnut)
A single strip of combined Artisan Rosewood and Boxwood for an elegant inlay.
• Available only on 5" models



#1007
EBONY SINGLE INLAY
(Shown on 14" x 5" Maple)
A solitary center inlay of imported Macassar Ebony.
• Available only on 5" models



SERIES COMPONENT

Reference, Reference Pure,
President Series



PRESIDENT SERIES DELUXE



#450 SILVER SPARKLE
PSD1455SE/C



#768 OCEAN RIPPLE
PSD1455SE/C

#767 DESERT RIPPLE

PSD1455SE/C	14" x 5.5"
SHELL	6-ply 7.5mm Luan
FINISH	#450 Silver Sparkle #767 Desert Ripple #768 Ocean Ripple
HOOPS	SuperHoop II (SH1408B/1408S)
LUGS	BLS55
RODS	T061L
MUFFLER	IM100W
STRAINER	SR17A / SR150E
SNARES	SN14201

RF1450S/C 14" x 5"

SHELL	20 ply (25mm) Maple 14 + Birch 6
HOOPS	MasterCast (DC1410/1410S)
LUGS	BRL55
RODS	SST5047 Stainless Steel
STRAINER	SR1000 Glide-Lock Strainer
SNARES	SN1420D Ultra Sound "D" type



RF1450S/C



RFP1450S/C

RFP1450S/C 14" x 5"

SHELL	6 ply (5.4 mm) Maple 4 + Birch 2
HOOPS	FatTone Hoops (FH1410/1410S)
LUGS	STL55L
RODS	SST5047 Stainless Steel
STRAINER	SR1000 Glide-Lock Strainer
SNARES	SN1420D Ultra-Sound "D" type



RFB1450



RFB1465

RFB1450 14" x 5"

SHELL	3mm Brass
HOOPS	MasterCast (DC1410/1410S)
LUGS	BRL55
RODS	SST5047 Stainless Steel
STRAINER	SR1000 Glide-Lock Strainer
SNARES	SN1420D Ultra Sound "D" type

RFB1465 14" x 6.5"

SHELL	3mm Brass
HOOPS	MasterCast (DC1410/1410S)
LUGS	BRL65
RODS	SST5042 Stainless Steel
STRAINER	SR1000 Glide-Lock Strainer
SNARES	SN1420D Ultra-Sound "D" type

RF1465S/C 14" x 6.5"

SHELL	20 ply (25mm) Maple 14 + Birch 6
HOOPS	MasterCast (DC1410/1410S)
LUGS	BRL65
RODS	SST5047 Stainless Steel
STRAINER	SR1000 Glide-Lock Strainer
SNARES	SN1420D Ultra Sound "D" type



RF1465S/C



RFP1465S/C

RFP1465S/C 14" x 6.5"

SHELL	6 ply (5.4 mm) Maple 4 + Birch 2
HOOPS	FatTone Hoops (FH1410/1410S)
LUGS	STL65
RODS	SST5047 Stainless Steel
STRAINER	SR1000 Glide-Lock Strainer
SNARES	SN1420D Ultra-Sound "D" type



RFS1450



RFS1465

RFS1450 14" x 5"

SHELL	2.5mm Cast Steel / 2.5mm R-Ring
HOOPS	MasterCast (DC1410/1410S)
LUGS	BRL55
RODS	SST5047 Stainless Steel
STRAINER	SR1000 Glide-Lock Strainer
SNARES	SN1420D Ultra-Sound "D" type

RFS1465 14" x 6.5"

SHELL	2.5mm Cast Steel / 2.5mm R-Ring
HOOPS	MasterCast (DC1410/1410S)
LUGS	BRL65
RODS	SST5047 Stainless Steel
STRAINER	SR1000 Glide-Lock Strainer
SNARES	SN1420D Ultra-Sound "D" type

RF1365S/C 13" x 6.5"

SHELL	20 ply (25mm) Maple 14 + Birch 6
HOOPS	MasterCast (DC1308/1308S)
LUGS	BRL65
RODS	SST5047 Stainless Steel
STRAINER	SR1000 Glide-Lock Strainer
SNARES	SN1320D Ultra Sound "D" type



RF1365S/C



RFP1365S/C

RFP1365S/C 13" x 6.5"

SHELL	6 ply (5.4 mm) Maple 4 + Birch 2
HOOPS	FatTone Hoops (FH1308/1308S)
LUGS	STL65
RODS	SST5047 Stainless Steel
STRAINER	SR1000 Glide-Lock Strainer
SNARES	SN1320D Ultra-Sound "D" type

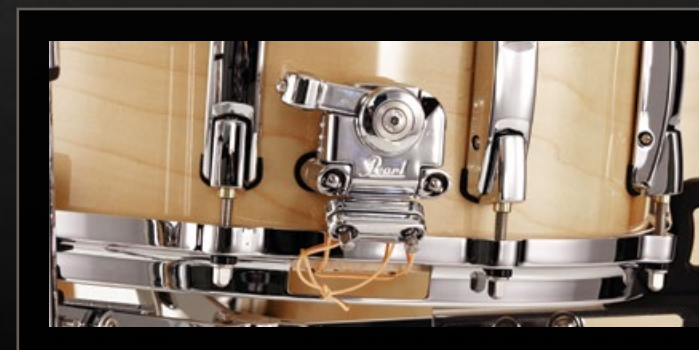

GLIDE-LOCK STRAINER

All Reference snare drums feature Pearl's SR1000 Glide-Lock Strainer, which includes a locking throw off lever and tension knob that won't loosen no matter how hard you play. Low friction technology permits smooth gliding action for ultra quiet and super precise motion.

U.S. Patent #7220905, #7301087, #7365256

SERIES COMPONENT

Masters, Session, & Decade
Classic Pearl Sound



DRUM SET SERIES SNARE DRUMS Made to match the sound and feel of your Pearl drum set.

MRV1455S/C 14" x 5.5"

SHELL 4 Ply Maple with 4 ply Maple Re-Rings
HOOPS FatTone (FH1410/1410S)
LUGS STL55
RODS SST5055 Stainless Steel
STRAINER SR017
SNARES S022N



MRV1455S/C

MRV1465S/C 14" x 6.5"

SHELL 4 Ply Maple with 4 ply Maple Re-Rings
HOOPS FatTone (FH1410/1410S)
LUGS STL65
RODS SST5047 Stainless Steel
STRAINER SR017
SNARES S022N



MRV1465S/C

MCT1455S/C 14" x 5.5"

SHELL 6 Ply Maple (5.4mm)
HOOPS SuperHoop II (SH1410B/1410S)
LUGS CL55
RODS T062
STRAINER SR017
SNARES S022N



MCT1455S/C

MCT1465S/C 14" x 6.5"

SHELL 6 Ply Maple (5.4mm)
HOOPS SuperHoop II (SH1410B/1410S)
LUGS CL65
RODS T061L
STRAINER SR017
SNARES S022N



MCT1465S/C

STS1480S/C 14" x 8"

SHELL 6-ply (5.4mm) Birch/African Mahogany
HOOPS SuperHoop II (SH1410B/1410S)
LUGS CL100
RODS T061L
STRAINER SR017
SNARES S022N



STS1480S/C

STS1465S/C 14" x 6.5"

SHELL 6-ply (5.4mm) Birch/African Mahogany
HOOPS SuperHoop II (SH1410B/1410S)
LUGS CL65
RODS T061L
STRAINER SR017
SNARES S022N



STS1465S/C

STS1455S/C 14" x 5.5"

SHELL 6-ply (5.4mm) Birch/African Mahogany
HOOPS SuperHoop II (SH1410B/1410S)
LUGS CL55
RODS T062
STRAINER SR017
SNARES S022N



STS1455S/C

DMP1455S/C 14" x 5.5"

SHELL 6 Ply Maple (5.4mm)
HOOPS 1.6mm Steel (RH1408/1408S)
LUGS NDL55/C
RODS TR5052
STRAINER SR700
SNARES SNW1420



DMP1455S/C

FREE FLOATING

The Ultimate Purity Of Sound

TASK-SPECIFIC INNOVATION Pearl's unique Free Floating Snare chassis removes all hardware from the shell to greatly improve resonance and projection.



By combining the tonal character of each shell type with its ideally matched depth, each Free Floating snare drum is engineered to fit a specific task by model and gives you a unique voice for any sonic situation.

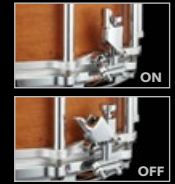

CLICK-LOCK THROW-OFF SYSTEM Engineered with Polymer bearings for precise and smooth action. Unique nylon grip mechanism locks the snares into place.



FTAL1480 Deep, rich snare power with short, even sustain decay.



FTMH1480 Ultimate in throaty, deep snare growl. Shortened decay.



FTPB1465 Lower overtone body, preserves crisp top-end snare snap.



FTMMH1465 Full, rounded bottom frequencies. Extra midrange body.



FTBR1450 Full-spectrum, both bright in punch and warm in tone.



FTMM1450 Punchy and smooth. A perfect "go-to" snare.



FTSS1435 1mm shell for bright, open attack with ringy overtone.



FTBB1435 Dense all Birch shell delivers bright, open attack.

FTAL1480 14" x 8"

SHELL 1.2mm Seamless Aluminum
HOOPS MasterCast (DC1410/DC1410S)
LUGS FT80
RODS SST5042
STRAINER SR160F
SNARES SN1442C

FTMH1480 14" x 8"

SHELL 8 ply (10mm) African Mahogany
HOOPS MasterCast (DC1410/DC1410S)
LUGS FT80
RODS SST5042
STRAINER SR160F
SNARES SN1442C

FTPB1465 14" x 6.5"

SHELL 1.2mm Phosphor Bronze
HOOPS MasterCast (DC1410/DC1410S)
LUGS FT65
RODS SST5042
STRAINER SR160F
SNARES SN1420C

FTMMH1465 14" x 6.5"

SHELL 6 ply (7.5mm) 4 ply Maple w/ 2 ply Inner African Mahogany
HOOPS MasterCast (DC1410/DC1410S)
LUGS FT65
RODS SST5042
STRAINER SR160F
SNARES SN1420C

FTBR1450 14" x 5"

SHELL 1mm Brass
HOOPS MasterCast (DC1410/DC1410S)
LUGS FT50
RODS SST5042
STRAINER SR160F
SNARES SN1420I

FTMM1450 14" x 5"

SHELL 6 ply (7.5mm) Maple
HOOPS MasterCast (DC1410/DC1410S)
LUGS FT50
RODS SST5042
STRAINER SR160F
SNARES SN1420I

FTSS1435 14" x 3.5"

SHELL 1mm Stainless Steel
HOOPS MasterCast (DC1410/DC1410S)
LUGS FT35
RODS SST5035
STRAINER SR160F
SNARES SN1420D

FTBB1435 14" x 3.5"

SHELL 6 ply (5.4mm) Birch
HOOPS MasterCast (DC1410/DC1410S)
LUGS FT35
RODS SST5035
STRAINER SR160F
SNARES SN1420D

SENSITONE HERITAGE ALLOY *Legendary Snare Tone from Studio to Stage*



The Sensitone sound has always been drawn from an amalgamation of The Heritage Alloys (Aluminum, Black-over-Brass, and Steel) for the necessary, immediate tones of yesterday's chart toppers with an undeniably modern sensibility.

Sensitone Heritage Alloy snare models employ these three original metal shell types to deliver essential tone and power with the right gig-ready touches.

STH1465BR

STH1450AL 14" x 5.5"

SHELL 1.2mm Seamless Aluminum
HOOPS SuperHoop II (SH1410B/1410S)
LUGS CL55
RODS T061L
STRAINER SR017
SNARES SN1420I



STH1450AL Dry, focused crack with quick decay.

STH1465AL 14" x 6.5"

SHELL 1.2mm Seamless Aluminum
HOOPS SuperHoop II (SH1410B/1410S)
LUGS CL65
RODS T061L
STRAINER SR017
SNARES SN1420I



STH1465AL Full, guttural snare bellow with little overtone.

STH1450BR 14" x 5.5"

SHELL 1mm Beaded Brass
HOOPS SuperHoop II (SH1410B/1410S)
LUGS CL55
RODS T061L
STRAINER SR017
SNARES SN1420I



STH1450BR Perfect blend of attack and brassy body.

STH1465BR 14" x 6.5"

SHELL 1mm Beaded Brass
HOOPS SuperHoop II (SH1410B/1410S)
LUGS CL65
RODS T061L
STRAINER SR017
SNARES SN1420I



STH1465BR An elegant solution for punch and warmth.

STH1450S 14" x 5"

SHELL 1mm Beaded Steel
HOOPS SuperHoop II (SH1410B/1410S)
LUGS CL55
RODS T061L
STRAINER SR017
SNARES SN1420I



STH1450S Crisp, sensitive high-pitched snap.

STH1465S 14" x 6.5"

SHELL 1mm Beaded Steel
HOOPS SuperHoop II (SH1410B/1410S)
LUGS CL65
RODS T061L
STRAINER SR017
SNARES SN1420I



STH1465S Belting crack with mild midrange overtone.

SIGNATURE SNARES

Capturing The Exclusive Sound of Drumming Legends



MM1465S/C

INTRODUCING THE WORLD'S FIRST "SMART" SNARE DRUM.

MATT MCGUIRE
The Chainsmokers

"Any snare drum I play has to cut through and connect. Not just a sonic connection when it's played, but actual, exclusive interaction between players. This is my Snare Drum. It's YOUR snare drum, and I can't wait for you to experience it."

PHOTO: DANILLO LEVINS

MATT MCGUIRE
MM1465S/C 14" x 6.5"

SHELL 1mm Steel/Black Shell
HOOPS SuperHoop II (SH1410/1410S)
LUGS CL65
RODS T061L
STRAINER SR017
SNARES SN1420I
FINISHES Custom Black
VENTS 30x

Made to bring the arena-filling sound to any drummer who plays it, the Matt McGuire Signature Snare features a 1mm Rolled Steel shell with 30 reinforced vents around the bottom edge. This unique design channels the force of each hit through its 6.5" deep chamber and outward in every direction like a shock wave. Its powder coated Matte Black finish further tempers its uniquely bright tone and Pearl's reliably durable SuperHoop II 2.3mm Hoops and CL Bridge Lugs add weight for increased projection.

NFC CHIP TECH

This Tour Edition drum is the first to feature imbedded NFC Chip technology. A simple tap with any Smartphone instantly unlocks exclusive content created by Matt himself.

SIGNATURE SNARES

Capturing The Exclusive Sound of Drumming Legends



MATT HALPERN

MH1460B	14" x 6"
SHELL	1.5mm Black Powder-Coated Brass
HOOPS	MasterCast (DCB1410/1410S)
LUGS	STL55MH/B
RODS	SST5052
STRAINER	SR150
SNARES	SN1420I
FINISHES	Custom Black
VENTS	AH03 (x3)



A Snare Drum from the Outer Limits of the Edge.



IAN PAICE

IP1465	14" x 6.5"
SHELL	Beaded Steel Shell
HOOPS	SuperHoop II (SH1410B/1410S)
LUGS	TB65 w/ TL20
RODS	SST5042 Stainless Steel (10)
STRAINER	SR017
SNARES	S022N
FINISHES	Chrome-Plated



A Timeless, Innovative Collaboration with a True Rock Legend.



BRIAN FRASIER-MOORE

BFM1455S/C	14" x 5.5"
SHELL	12-Ply, 15mm Gum/Maple/Gum
HOOPS	MasterCast (DC1410/DC1410S)
LUGS	CL55
RODS	T062
STRAINER	SR150
SNARES	SN1442I
FINISHES	Gloss Gumwood Naturalburst



A Truly Inspiring Snare Drum.



OMAR HAKIM

OH1350	13" x 5"
SHELL	6 ply African Mahogany Shell
HOOPS	2.3mm SuperHoop II (SH1308/1308S)
LUGS	CL55
RODS	SST5047 Stainless Steel (8)
STRAINER	SR015 Gladstone Style
SNARES	S029N
FINISHES	#140 Natural Mahogany



A "Power Piccolo" for a Sonic Blend of Power, Projection and Tonal Color.



DENNIS CHAMBERS

DC1450S/N	14" x 5"
SHELL	Cast Aluminum: 3mm w/ 2mm R. Rings
HOOPS	SuperHoop II (SHN1412B/1408S)
LUGS	STL100 (12 over 8)
RODS	SST5047 Stainless Steel (20)
STRAINER	SR020 Multi-Trace Strainer System
SNARES	SN1420I
FINISHES	Black Nickel Shell w/ Nickel Hardware



A Commanding Snare Sound Fit For Royalty.



JOEY JORDISON

JJ1365N	13" x 6.5"
SHELL	Steel/Black Shell
HOOPS	SuperHoop II (SHB1308/1308S)
LUGS	CL65B
RODS	SST5047 Stainless Steel (10)
STRAINER	SR017/B
SNARES	S029N
FINISHES	Custom Black



A Fierce, Ferocious, Fast Snare fit for a Metal Drumming Legend.

HYBRID EXOTIC

For the ultimate in power and prestige. Shell choices include spun-composite, seamless Cast Aluminum, and Kapur/Fiberglass.

Space-Age Precision,
Timeless Tone



GLIDE-LOCK THROW-OFF SYSTEM Pearl's SR1000 Glide-Lock Strainer's locking throw-off lever and tension knob assures worry free, slip-free performance from all Hybrid Exotic Snare Drums. (U.S. Patent #7220905, #7301087, #7365256.)



SPIN-TIGHT™ TENSION RODS To maintain tuning tension across the batter head, all Hybrid Exotic snare drums feature Pearl's Spin-Tight tension rods. This elegantly simple innovation creates a tension rod-within-a-tension rod, that allows the rod to expand and lock into place within the swivel nut. Utilizing a special drum key, tunings can be controlled under high-impact play like never before.



HEP1450 14" x 5"

SHELL VectorCast
HOOPS SuperHoop II (SH1410B/1410S)
LUGS STL100
RODS SPT5047 (top) - SST5047 (bottom)
STRAINER SR1000
SNARES SN1420C



HEP1450 Quick, yielding snap with heavy midrange overtones.

HEP1465 14" x 6.5"

SHELL VectorCast
HOOPS SuperHoop II (SH1410B/1410S)
LUGS STL100
RODS SPT5047 (top) - SST5047 (bottom)
STRAINER SR1000
SNARES SN1420C



HEP1465 Full-Spectrum snare body with thick bottom-end tonality.



HEAL1450 Dry, high-pitched crack with little overtone.



HEK1450 Articulate snare punch, best at higher tunings.

HEAL1450 14" x 5"

SHELL Cast Aluminum:
3mm w/ 2mm R-Rings
HOOPS SuperHoop II (SH1410B/1410S)
LUGS STL100
RODS SPT5047 (top) - SST5047 (bottom)
STRAINER SR1000
SNARES SN1420I

HEK1450 14" x 5"

SHELL 6 ply 7.5mm
Kapur w/ Inner Fiberglass
HOOPS SuperHoop II (SH1410B/1410S)
LUGS STL100
RODS SPT5047 (top) - SST5047 (bottom)
STRAINER SR1000
SNARES SN1420D

DUOLUXE

The World's First Inlaid Brass Snare Drum



The Pearl Duoluxe is a modern take on our legendary, "interplanetary" snare drum sound. Featuring the chrome-over-brass shell alloy of our classic Jupiter snare, the rigidity of our trademark dual inverted shell beads is augmented with inlaid finish bands of Nicotine White Marine Pearl. This gives the shell a singular look and adds tonal control to its unbridled sound.

Each DuoLuxe snare is fitted with retro-perfect "Battleship" Lugs, smooth SR017 Strainer, and solid 2.3mm SuperHoop II triple-flanged hoops to balance out the package. Experience the Jupiter sound with a fresh, dynamic look for a totally graceful drumming presence.

DUX1450BR 14" x 5"

SHELL 1mm Dual-Beaded Chrome/Brass
HOOPS SuperHoop II (SH1410B/1410S)
INLAY #405 Nicotine White Marine Pearl (x2)
LUGS BSL55
RODS SST5042
STRAINER SR017
SNARES SN1420I



DUX1450BR Bold and crisp with short midrange overtone.

DUX1465BR 14" x 6.5"

SHELL 1mm Dual-Beaded Chrome/Brass
HOOPS SuperHoop II (SH1410B/1410S)
INLAY #405 Nicotine White Marine Pearl (x2)
LUGS BSL55
RODS SST5055
STRAINER SR017
SNARES SN1420I



DUX1465BR Fierce and centered mid-to-low sustain.

STAVECRAFT

Featuring The Exclusive Dado-Loc Joint



A startling addition to any pro drummer's soundscape, each StaveCraft shell starts from two layers of meticulously beveled solid Makha or ThaiOak staves. Dado-Loc, an old world principal exclusive to these snares, inserts a segment of corresponding wood into the center Dado channel formed by each stave and increases total shell strength by 50%. This solid fusion of hardwoods is lathed to a perfectly round 25mm thickness for unparalleled volume and power.

StaveCraft available in #186 Hand Rubbed Satin Natural Finish



SCD1450TO186 Quick, tight high-range tonal power.



SCD1465TO186 Sensitive, centered low-overtone drive.



SCD1450MK186 Cracking tonal pop with short midrange hum.



SCD1465MK186 Thick, cavernous sonic body with cutting punch.

SCD1450TO186 14" x 5"

SHELL 25mm Dual Thai Oak Stave w/ Makha DadoLoc
HOOPS MasterCast (DC1410/DC1410S)
LUGS STL55L
RODS SST5042
STRAINER SR150 ClickLock
SNARES SN1420I

SCD1465TO186 14" x 6.5"

SHELL 25mm Dual Thai Oak Stave w/ Makha DadoLoc
HOOPS MasterCast (DC1410/DC1410S)
LUGS STL65
RODS SST5047
STRAINER SR150 ClickLock
SNARES SN1420I

SCD1450MK186 14" x 5"

SHELL 25mm Dual Makha Stave w/ Thai Oak DadoLoc
HOOPS MasterCast (DC1410/DC1410S)
LUGS STL55L
RODS SST5042
STRAINER SR150 ClickLock
SNARES SN1420I

SCD1465MK186 14" x 6.5"

SHELL 25mm Dual Makha Stave w/ Thai Oak DadoLoc
HOOPS MasterCast (DC1410/DC1410S)
LUGS STL65
RODS SST5047
STRAINER SR150 ClickLock
SNARES SN1420I

UTILITY

MODERN UTILITY snare drums are vital instruments to make the gig great. Fusing reliability and flexibility for today's demanding gigging environment, Pearl has developed Modern Utility: a line of no-nonsense, well-appointed snare drums priced with the active working player in mind. Flexible enough to add to any setup and strong enough to stand up to constant play.

See Korn drummer Ray Luzier's performance test of each Modern Utility snare at pearldrums.com



Leg Brackets: FTB07 (x3)

Versatile Drums for Secondary Effects

MUS1410FM 14" x 10"

SHELL 6 ply Maple (5.4mm)
HOOPS 1.6mm Steel (RH1408/1408S)
LUGS CL100
RODS TR5052 (16)
STRAINER SR017
SNARES SNW1420
FINISHES Satin Brown (#220)



MUS1410FM

MUS1480M 14" x 8"

SHELL 6 Ply Maple (5.4mm)
HOOPS 1.6mm Steel (RH1408/1408S)
LUGS CL100
RODS TR5052 (16)
STRAINER SR017
SNARES SNW1420
FINISHES #224 Matte Natural, #227 Satin Black



MUS1480M

MUS1455M 14" x 5.5"

SHELL 6 ply Maple (5.4mm)
HOOPS 1.6mm Steel (RH1408/1408S)
LUGS CL55
RODS TR5052 (16)
STRAINER SR700
SNARES SNW1420
FINISHES #224 Matte Natural, #227 Satin Black



MUS1455M

MUS1465M 14" x 6.5"

SHELL 6 ply Maple (5.4mm)
HOOPS 1.6mm Steel (RH1408/1408S)
LUGS CL65
RODS TR5047 (16)
STRAINER SR700
SNARES SNW1420
FINISHES #224 Matte Natural, #227 Satin Black



MUS1465M

MUS1350M 13" x 5"

SHELL 6 ply Maple (5.4mm)
HOOPS 1.6mm Steel (RH1308/1308S)
LUGS CL55
RODS TR5047 (16)
STRAINER SR700
SNARES SNW1316
FINISHES #224 Matte Natural, #227 Satin Black



MUS1350M

MUS1270M 12" x 7"

SHELL 6 ply Maple (5.4mm)
HOOPS 1.6mm Steel (RH1206/1206S)
LUGS CL65
RODS TR5057 (12)
STRAINER SR017
SNARES SNW1216
FINISHES #224 Matte Natural, #227 Satin Black



MUS1270M

EFFECTS

Added Voices, Timbres, and Sounds in Your Ever-Evolving Setup



SFS10/C31 10" x 4.5"

SHELL 6 Ply Poplar
HOOPS 1.6mm Steel (RIM1006RSH/RIM1006RS)
LUGS MSFL35
RODS RSHT3240 (12)
STRAINER SR02MSFL/SR02EMSFL
SNARES SN10MSFL



M1060 10" x 6"

SHELL 6 Ply Maple (7.5mm)
HOOPS Super Hoop II (SH1006/1006S)
LUGS CL65
RODS SST5035 (12)
STRAINER SR018
SNARES S032N



M1270 12" x 7"

SHELL 8 Ply Maple (10mm)
HOOPS 1.6mm Steel (RIM1208B/1208S)
LUGS CL100
RODS SST5047 Stainless Steel (16)
STRAINER SR018
SNARES S031N

EFFECTS SNARES



B1330 13" x 3"

SHELL 1.0mm Brass
HOOPS 1.6mm Steel (RIM1308B/1308S)
LUGS CL05
RODS T055 (16)
STRAINER SR018
SNARES S029N



S1330B 13" x 3"

SHELL 1.0mm Black-finish Steel
HOOPS 1.6mm Steel (RIM1308B/1308S)
LUGS CL05
RODS T055 (16)
STRAINER SR018
SNARES S029N



M1330 13" x 3"

SHELL 6ply Maple (7.5mm)
HOOPS 1.6mm Steel (RIM1308B/1308S)
LUGS CL05
RODS T055 (16)
STRAINER SR018
SNARES S029N

PICCOLO



FCP1250 12" x 5"

SHELL 8 ply Poplar (10mm)
HOOPS 1.6mm Steel (RIM1206/1206SL)
LUGS CL50
RODS T061L (12)
STRAINER SR018
SNARES S031



FCS1050 10" x 5"

SHELL 1.0mm Steel
HOOPS 1.6mm Steel (RIM1006/1006SL)
LUGS CL50
RODS T061L (12)
STRAINER SR018
SNARES S032

FIRECRACKER

COLLABORATION

CASEY COOPER @COOP3RDRUMM3R



CC1450S/C 14" x 5"

SHELL 6-ply 6.8mm Poplar/Maple
HOOPS 1.6mm Steel (RH1408/1408S)
LUGS CL55
RODS TR5047 (16)
STRAINER SR700
SNARES SNW1420
FINISHES Artisan II Flame Wrap



THE IGNITER To capture the searing energy of drumming for a new generation of players, Pearl collaborated with viral video drummer Casey Cooper to create The Igniter. Specifically created to instantly improve the sound of any student drum kit, it's a fantastic value to keep the fire of drumming burning bright!



e/MERGE

Powered by
KORG

EMHWP

The foundation of the e/MERGE electronic drum set is a custom designed, chrome plated ICON e-Rack system.



e/TRADITIONAL CONFIGURATION

10", 12" and 14" toms, a 14" snare, and PUREtouch Kick Pad. PUREtouch Cymbals, ICON e-Rack, MDL1 Module.
EM53T



e/HYBRID CONFIGURATION

10", 12" and 14" toms, a 14" snare, and 18" acoustic bass drum. PUREtouch Cymbals, ICON e-Rack, MDL1 Module.
EM53HB

e/MERGE

**NOT JUST A NEW STANDARD.
A NEW SOUND. A NEW FEEL. AND, A
COMPLETELY NEW E-DRUMMING EXPERIENCE.**

e/MERGE is about change, and change in the e-drum market has been way overdue. When we looked closely at every aspect of the current e-drumming experience with KORG, together we knew we could make a dramatic difference. And that difference begins with the all new e/MERGE module. Simple yet elegant in design, the e/MERGE MDL1 module features a full library of high definition, natural, organic and minimally processed acoustic Pearl drums. We then added the very best electronic, world, orchestral and specialty percussion sounds from KORG's vast library of pristine quality samples. But, the module is only part of the change.

There are three key elements that separate e/MERGE from anything that has come before. The MDL1 e/MERGE Module, KORG's amazing WAVE TRIGGER TECHNOLOGY and Pearl's acoustic-like PUREtouch electronic pads and cymbals combine to create an exceptional e-drumming experience.

MDL1



e/MERGE MDL1 MODULE Simple, straight forward yet extremely powerful, the MDL1 module offers, a pair of powerful multicore processors, a full library of acoustic Pearl drums recorded in one of the world's most renowned studios, pristine samples from KORG's library and the variety of routing options every e-drummer needs.



WAVE TRIGGER TECHNOLOGY

This ultra-fast and highly sensitive technology partially based upon KORG's groundbreaking Wave Drum allows even your stick choice to make a discernible difference in the sound of your drum. Wave Trigger Technology speed adds a realism to the playing experience never before available to the e-drummer.

PUREtouch

PUREtouch PADS & CYMBALS

Perfectly sized pads designed to replicate the ultimate acoustic-like response. PUREtouch features layer upon layer of specially designed materials each selected for a specific quality that together create an e-experience never before possible. (PUREtouch Pads U.S. Patent #10475424) (PUREtouch Hi-Hats U.S. Patents #10475430, 10482855)

MODULE SPECIFICATIONS



SOUND GENERATOR	2 CPU (4 core + 2 core) 128 Voices
POLYPHONY	700 HD Sound Library
VOICE	35 HD Kits
DRUM KIT	36
EFFECTS	44.1kHz, 16 Bit WAV
SONG RECORDING TIME	Approximately 12 Hours
SONG RECORDING TYPE	BPM 30 - 300
CLICK TEMPO	1/2 - 24/2, 1/4 - 24/4, 1/8 - 24/8, 1 - 24/8T, 1/16 - 24/16 (T=Triplet)
BEAT	10
CLICK VOICES	Knobs and Ambient Slider Control
CONTROLLERS	3.25" x 1" Graphic LCD
DISPLAY	Master Out L/Mono & R
CONNECTORS	Direct Out (8) Headphones Out Aux In TRS Mini Main Trigger Inputs (DB-25 Connector) Accessory Inputs (3) USB to PC Port (Transport USB Audio & MIDI Data) USB-A (for WAV files and Settings Data)
MIDI	MIDI Output
POWER SUPPLY	100-120V, 50-60Hz, Switching Power Supply
DIMENSIONS, WEIGHT	2.2lbs, 9" W x 7.5" D x 2" H

MIMIC PRO

Download MIMIC PRO Software Updates and User Manual at pearl-electronics-support.com

Powered by Slate



MIMP24B

MIMIC PRO

STATE OF THE ART FEATURES:

- 7" IPS Touch Screen with Programmable Data Wheel
- 120 gig Solid State drive
- 16 Dual Zone Inputs
- 16 Programmable Audio Outputs
- MIDI In and Out
- High Quality Digital to Analog Converters
- Two completely separate mixers for headphone and Main outs (Drummer gets a personal mix with and without effects independent of Main outputs)
- Import Wave, Aiff or MP3 sound files
- Compatible with most pads on the market
- Steven Slate Drums 5 Library
- 24 bit multi channel sample library with separate adjustment of Close, Overhead and Room mics
- Onboard effects include EQ, Compression, Reverb with Room Sizes
- Individual Cymbal Volume Adjustments for Bell, Bow, Edge, Chik and Splash
- All AUX and Cymbal inputs have choke function
- Supports triple and dual zone cymbals and dual zone hi hat
- SD card slot and USB
- Additional Instruments and Libraries will be available
- Stereo Aux In and Onboard Metronome
- Internal Recording for Loops and/or Performances

THE MOST AMAZING DRUM MODULE THE WORLD HAS EVER KNOWN.

SERIOUSLY, IT'S THAT GOOD.



Superior sound, accurate triggering and connectivity are the most important features of a drum module. Pearl Drums and Steven Slate have joined forces to create "Mimic Pro" - the world's most advanced percussion sound source for studio and live performance applications.

At the heart of this ground breaking unit is the new Steven Slate 5 drum library that features multi-channel drum samples recorded in world class studios. Each instrument supports adjustment of Attack, Sustain, Release, Tune, Pan and volume. Instead of substituting digital effects to create ambience, these instruments use the actual ambient recordings with separate adjustment of close, overhead and room mics.

Mimic Pro is the first drum module to implement a 7" IPS touch screen and the first to offer 2 mixers for independent headphone and front house outputs. Now that the drummer is responsible for triggering loops and other sounds for a performance, Mimic Pro can import audio files to trigger from your pads.

Storage is no longer a problem with Mimic's 120GB Solid State Drive and lightning fast loading time. Speaking of connectivity, Mimic Pro is compatible with Pearl TruTrac pads and a host of pads from other manufacturers. Top that off with sixteen audio outs, 16 Trigger inputs, independent SD card Slot, USB and Midi In & Out, Stereo Aux input and you would be hard pressed to find a better option for today's musician.



malletSTATION

The World's First 3.0 Octave Adjustable Range Electronic Mallet Controller

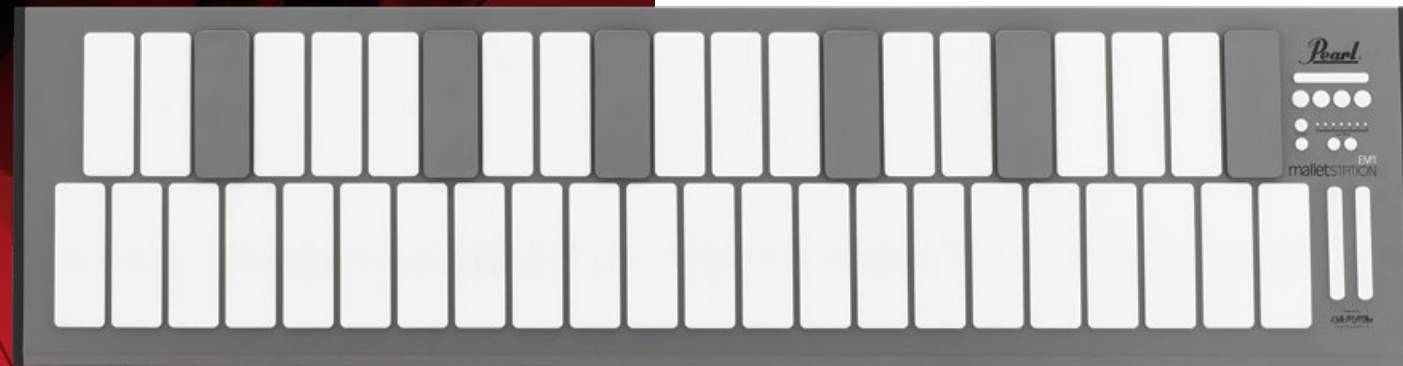

Shown Mounted on Vibraphone with Field Frame



Sleek, modern design with an ultra thin 1.6" profile



1.75" x 5" Soft Silicone Keys powered by KMI Smart Fabric Sensor Technology

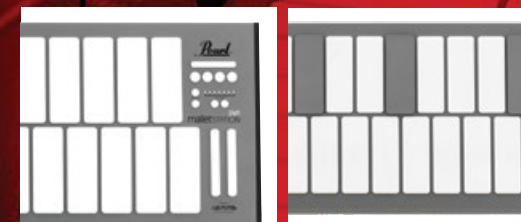

Software Assignable Control Panel with 3 Faders, 4 Buttons, plus Low Note and Octave Shift

Moveable Accidental "Gap Caps" for visual cues when low note range is adjusted



Jack panel with USB MIDI, MIDI expander port, and 3 MIDI assignable 1/4" pedal inputs

Optional Dual Module Mounts allow malletSTATION to easily mount on racks, stands, and field frames

malletSTATION™ EM1

PRACTICE, PERFORM, COMPOSE ANYWHERE.

- USB Powered MIDI Mallet Keyboard Controller
- Universal Compatibility through phone/tablet/laptop
- Tech-Forward Design featuring KMI Smart Fabric Sensors
- Low Note, Adjustable, User defined 3.0 Octave Range
- Customizable mallet dampening and aftertouch modes for realistic performance techniques
- Natural feeling soft silicone keys, all-weather playing surface
- Assignable buttons and faders for customized control and functions
- Three assignable pedal inputs for expression and sustain
- Hybrid Aluminum and Steel Chassis design for durability and stability
- Optional MIDI Expander to use external MIDI Hardware (sold separately)
- Flexible mounting on desktop, X-stand, or module mounts (sold separately)
- Mounting plates, stands, cases, covers, and other peripherals (available separately)

- 43, 1.75" x 5" soft silicone keys
- 3 faders and 4 buttons, MIDI assignable
- 3 MIDI assignable 1/4" pedal inputs
- Bottom Note Range Shift up/down buttons
- Octave up/down buttons
- 1.6" H x 12.6" W x 49" L
- 22.5 lbs

Pearl once again redefines the electronic percussion experience by introducing the revolutionary EM1 malletSTATION adjustable range electronic mallet controller.

The EM1 malletSTATION is a 3.0 octave adjustable range electronic mallet controller designed for all levels of player, from the beginning student through the gigging professional. The adjustable range function allows you to set the fundamental diatonic note of the instrument to what you need—low D xylophone? No problem! Powered exclusively by USB Bus Power, the malletSTATION is designed to be used with Mac, PC, iPad, iPhone, and Android devices, making it the first truly portable mallet percussion controller on the market.

Designed in collaboration with Keith McMillen Instruments, malletSTATION's tech-forward design features KMI's Smart Fabric Sensor technology allowing the silicone bar material to have an extremely sensitive, natural response, including mallet dampening and aftertouch control, and all can be easily tailored to your individual playing style. The EM1 features a master control section, with 3 programmable faders, 4 programmable buttons, and the fixed function low note and octave shift buttons. In addition, three assignable pedal inputs allow for flexibility in performance such as sustain, expression, or any MIDI parameter of your choice. These controls are fully programmable through a software editor so changing your configuration is as easy as clicking a mouse.

This is the controller that will grow with you throughout your playing career—from music apps on your phone or tablet, to professional digital audio workstations and sound libraries—your sounds and even the instruments you play are only limited by the software you run.

DEMON PEDALS

DEMON DRIVE UNLEASH THE DEMON

Demon Drive's lightning fast power and silky smooth finesse make it the choice of the drumming world's most prolific players. Featuring an amazing array of adjustable features, from beater angle, traction plate grip, and footboard height and angle, Demon Drive truly becomes an extension of your body. Its totally modular design makes it configurable in a variety of single and double pedal setups. Unleash the Demon and find out what custom feel is all about.



U.S. Patent #7579540

A choice of 2 positions for a finesse or power feel. Simply loosen the clamshell to change position.



DIRECT LINK
Dual position adjustment for LIGHT or HEAVY feel, creating a seamless link between your foot and the bass drum.

Demon Direct Drive
(Shown in Shortboard Set Up)
P3000D

P3000D DEMON DRIVE

DRIVE	Direct Drive
FOOT BOARD	Duo-Deck Convertible
LINK ADJUSTMENT	Dual Position
BEATER	Control Core
TENSION ADJUSTMENT	Click-Lock
PEDAL HEIGHT	Infinitely Adjustable
BEATER ANGLE	Infinitely Adjustable
CASE	Included



CLICK-LOCK
Secures spring tension in high impact play.
(U.S. Patent #7754953)



DUO-DECK FOOTBOARD
The world's first convertible footboard can switch from a traditional shortboard to a longboard pedal in seconds.
(U.S. Patent #7626107)

The Fastest, Smoothest, Most Powerful Pedals in the World



DEMON DRIVE BEATER w/ Control Core Elastomer Center: Reduces impact vibration.
(U.S. Patent #7626108)



NINJA BEARINGS
Designed for Pro Skateboarding, each bearing features micro-polished balls for minimal friction and unmatched speed.



Direct Drive Double Pedal
(Shown in Longboard Setting)
P3002D

Single Pedal Complete	P3000D
Double Pedal Complete (right footed)	P3002D
Double Pedal Conversion Kit (right footed)	P3001D
Double Pedal Complete (left footed)	P3002DL

ADJUSTABLE TRACTION PLATE

DUO-DECK FOOTBOARD

CONTROL CORE BEATERS

INDEPENDENT BEATER ANGLE AND FOOTBOARD HEIGHT ADJUSTMENTS

ELIMINATOR DEMON PEDALS

HEAVENLY FEEL... WICKEDLY FAST

DEMON CHAIN TRADITIONAL FEEL AND POWER OF A CHAIN

An innovative combination of Demon Drive speed and traditional chain drive feel, the Demon Chain's Perfect Circle cam delivers smooth, consistent response throughout the stroke for pinpoint accuracy and control. A high performance package for the driven power drummer.

PERFECT CIRCLE CAM

PIVOTING HOOP CLAMP

MULTI FUNCTION DRUM KEY

P3000C DEMON CHAIN

DRIVE	Ultralight Chain
FOOT BOARD	Duo-Deck Convertible
DRIVE CAM	Perfect Circle "Linear Response" Cam
BEATER	Control Core
TENSION ADJUSTMENT	Click-Lock
DRIVE BEARINGS	NiNJA Low-Friction
PEDAL HEIGHT	Infinitely Adjustable

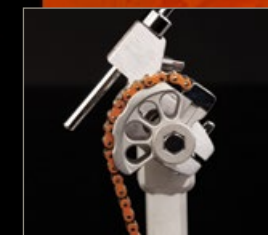

PERFECT CIRCLE CAM
Its racing inspired lines transfer energy from your foot into the head with minimal mass and maximum speed.



POWER CHAIN
This ultra lightweight, dual linkage Chain features low friction rollers for power and dependability.



Chain Drive Double Pedal (Shown in Shortboard Setting)
P3002C



Z-LINK DRIVE SHAFT Delivering the same precise action of the primary pedal in the secondary pedal, the Z-Link features hand assembled, CNC machined construction. Features Pearl's exclusive Zero Latency Universal Joints, and precision radial ball bearings.

Single Pedal Complete	P3000C
Double Pedal Complete (right footed)	P3002C
Double Pedal Conversion Kit (right footed)	P3001C
Double Pedal Complete (left footed)	P3002CL

EQUIPMENT FAILURE IS NOT AN OPTION, END OF STORY.

Pearl's hardware is LEGENDARY. So rugged, sure-footed, and built to last that we back it up with PEARL'S EXCLUSIVE Lifetime Warranty.

Demon Chain Drive
(Shown in Longboard Set Up)
P3000C

BEATER HEIGHT ADJUSTMENT

NINJA BEARINGS

ELIMINATOR: REDLINE

The Key to Ultimate Bass Drum Performance



Eliminator: Redline Single Pedal, Chain Drive P2050C

CHAIN OR BELT DRIVE

*Shown w/ Optional Red Cam

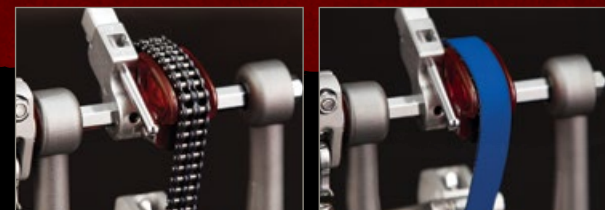

The sprocketless double chain drive on the Eliminator Redline (P2050C) provides super smooth action with powerful and precise feel. The Eliminator Belt Drive model (P2050B) provides a very comfortable, natural feel similar to a direct-drive system.

P2050C ELIMINATOR: REDLINE CHAIN

DRIVE Sprocketless Double Chain
 FOOT BOARD Redline Reversible Traction Plate
 DRIVE BEARINGS NiNJA Low-Friction
 BEATER Control Core Quadbeater
 TENSION ADJUSTMENT Click-Lock
 BEATER ANGLE Uni-Lock Infinitely Adjustable
 POWERSHIFTER Three Position
 CASE Included
 HEEL PLATE HINGE Zero Play (U.S. Patent #7179978)

P2050B ELIMINATOR: REDLINE BELT

DRIVE Belt-Reinforced Nylon Strap
 FOOT BOARD Redline Reversible Traction Plate
 DRIVE BEARINGS NiNJA Low-Friction
 BEATER Control Core Quadbeater
 TENSION ADJUSTMENT Click-Lock
 BEATER ANGLE Uni-Lock Infinitely Adjustable
 POWERSHIFTER Three Position
 CASE Included
 HEEL PLATE HINGE Zero Play (U.S. Patent #7179978)

ELIMINATOR REDLINE

CHOOSE A CAM REDLINE YOUR PERFORMANCE

The world's only pedal featuring the Patented Interchangeable Cam System, Eliminator: Redline's virtually unlimited tunability lets you lock in personally tuned feel, power, and speed. Like having four pedals in one, Redline pushes the boundaries of bass drum performance by fusing the power and flexibility of Pearl's original Eliminator with the fluid speed of our Demon series pedals.

INTERCHANGEABLE CAM SYSTEM

Provides a choice of 6 different color-coded cams (4 included and 2 more optional). Quickly changes the power and feel of the pedal to suit your individual playing needs. Changing the cam is as simple as pushing the release button and snapping another in place.

BLACK CAMTBK
Linear action cam

WHITE CAMTWT
Oversized linear cam

BLUE CAMTBL
Progressive cam

RED CAMTRD
Radical progressive cam

PURPLE CAMPL
Aggressive action cam (Optional)

YELLOW CAMYL
Inverse action cam (Optional)

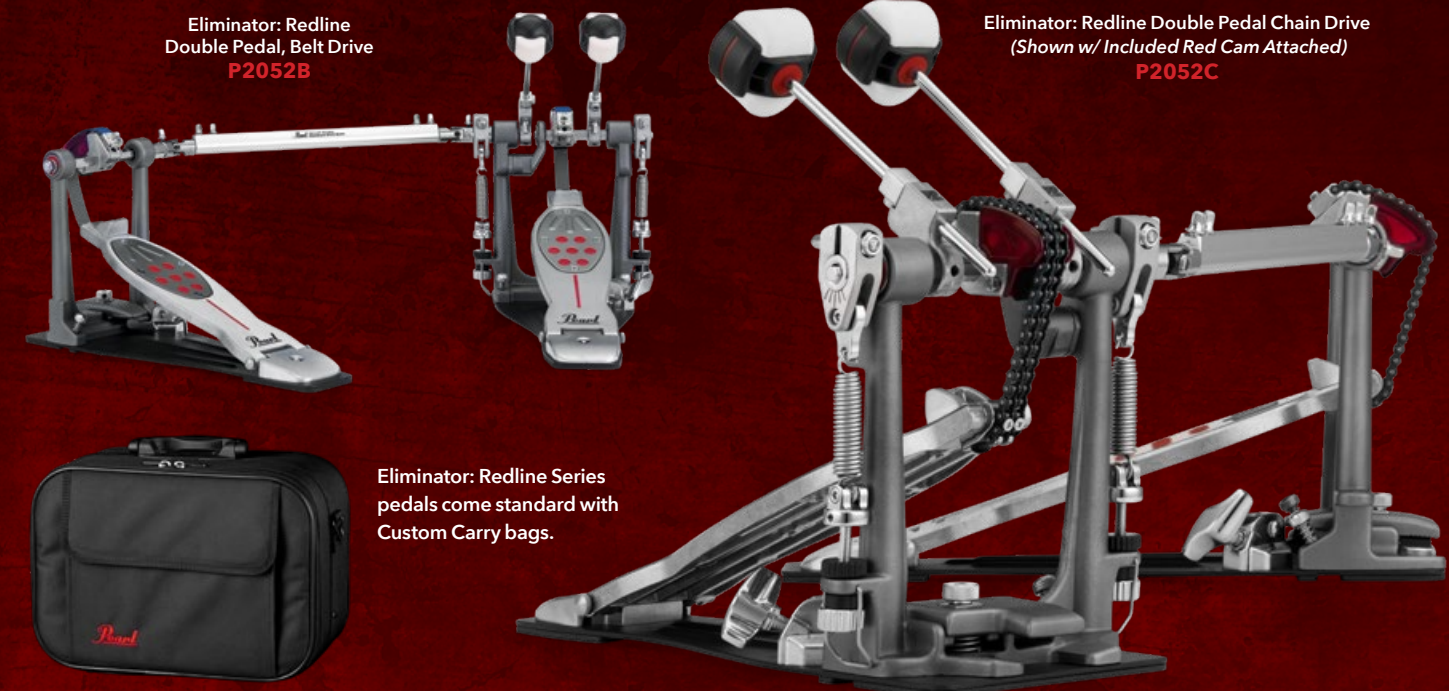

Eliminator: Redline Double Pedal, Belt Drive P2052B

Eliminator: Redline Double Pedal Chain Drive (Shown w/ Included Red Cam Attached) P2052C

Eliminator: Redline Series pedals come standard with Custom Carry bags.

POWERSHIFTER FUNCTION By moving the foot board forward or back, our revolutionary PowerShifter function provides 3 positions to fine tune the power and feel of the pedal. Instantly change the drive angle leverage to create a light, regular, or strong feel. U.S. Patent #5574237

NiNJA BEARINGS Developed by skateboarding engineers for the ultimate in fast, quiet performance, NiNJA Bearings incorporate state of the art micropolished steel balls for incredibly fast and smooth performance.

INDEPENDENT TRACTION GRIPS Eliminator Redline's redesigned pedalboard features Pearl's exclusive reversible Traction Plate insert, allowing individual traction grip configuration to suit your exact playing requirements.

CLICK-LOCK SPRING ADJUSTMENT w/ NEW Rotor Tension Cradle. Secures spring tension in high impact play. The counter spring adjustment's rolling cradle allows the spring to pivot with each stroke for less resistance. U.S. Patent #7754953

ZERO PLAY HINGE Our proprietary stainless steel hinge provides maximum freedom of motion for blazing speed and prevents play between the footboard and heel. U.S. Patent #7179978

ROLLER HOOP CLAMP w/ Side Mount Adjustment. Quickly adapts to a wide range of hoop thicknesses for the smoothest, most secure grip possible. Easy side access to the hoop clamp makes set up and tear down a breeze.

THE CONTROL CORE QUADBEATER Provides four beater surfaces (two hard plastic, two felt) with the added feel of the vibration-free Control Core elastomer center. U.S. Patent #7626108

UNI-LOCK BEATER ANGLE CAM Grips the axle a full 360 degrees, allowing infinite beater angle adjustments. Floating Spring Pendulum design is perfectly centered on the clamp for full bearing movement and maximum smoothness.

ELIMINATOR SOLO

Singular Feel, Eliminator Speed, Priced to Perform. Fly Solo and Set Your Feet Free!

ELIMINATOR SOLO: BLACK

Delivering blinding speed and powerful performance, Eliminator Solo bass drum pedals put the fleet footed player in control with all the gliding velocity that made Pearl pedals revolutionary. These no nonsense, streamlined Eliminator models deliver singular, resistance free feel for effortless play and driving performance.

The Solo: Black pedal's even, slightly weighted feel delivers just the right amount of resistance without slowing your stroke - for increased power and less muscle fatigue.

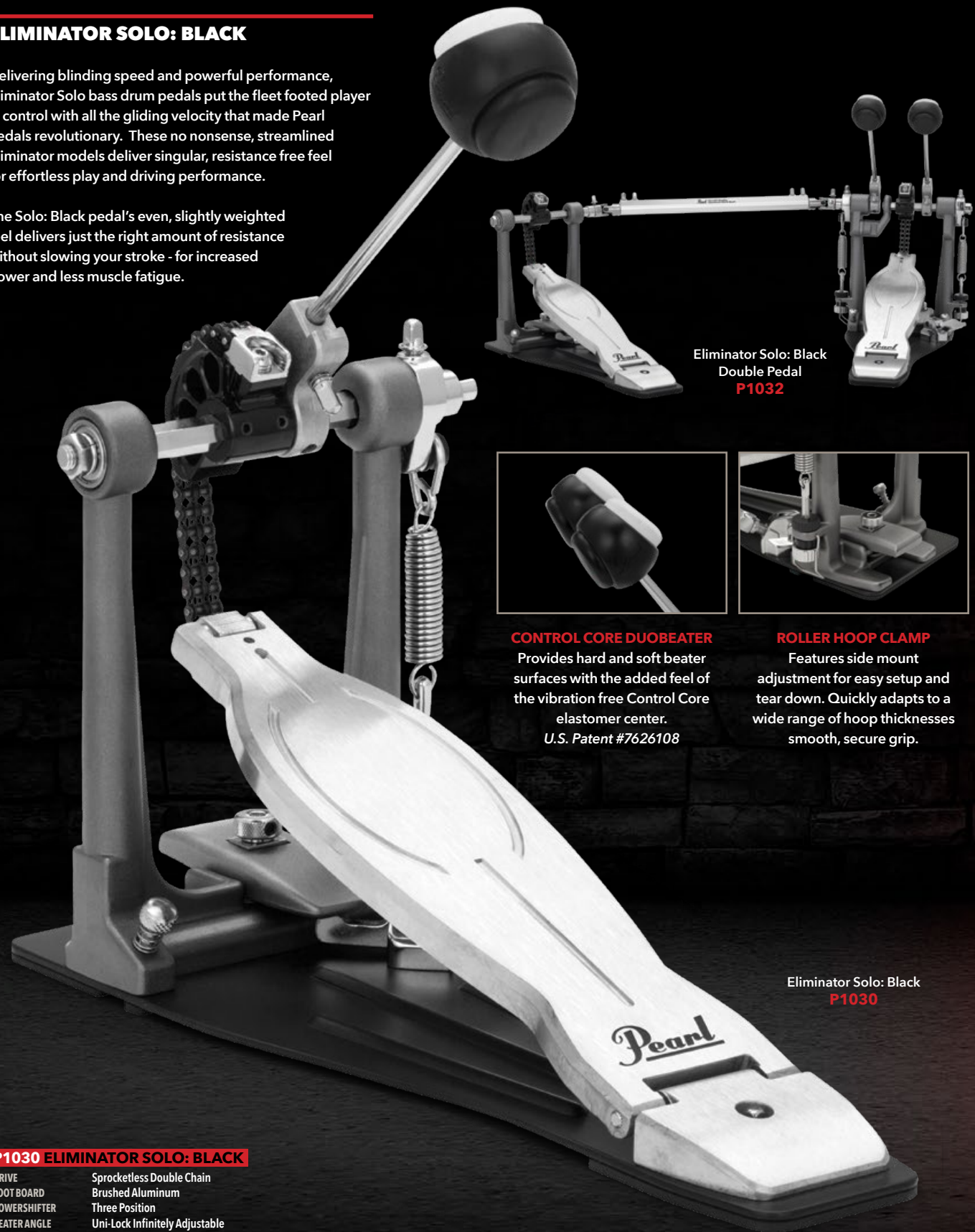

Eliminator Solo: Black Double Pedal P1032

Eliminator Solo: Black P1030



CONTROL CORE DUOBEATER
Provides hard and soft beater surfaces with the added feel of the vibration free Control Core elastomer center.
U.S. Patent #7626108



ROLLER HOOP CLAMP
Features side mount adjustment for easy setup and tear down. Quickly adapts to a wide range of hoop thicknesses smooth, secure grip.

P1030 ELIMINATOR SOLO: BLACK

DRIVE	Sprocketless Double Chain
FOOT BOARD	Brushed Aluminum
POWERSHIFTER	Three Position
BEATER ANGLE	Uni-Lock Infinitely Adjustable
ROLLER HOOP CLAMP	Side Mount Adjustment
TENSION ADJUSTMENT	Click-Lock
BEATER	Control Core DuoBeater

ELIMINATOR

ELIMINATOR SOLO: RED

Delivering accurate speed and focused performance, the Eliminator Solo: Red bass drum pedal delivers no-nonsense Eliminator feel for the technically decisive player.

Focusing the drive on the accurate feel of the Radical Progressive Action of Eliminator: Redline Red Cam, its shape allows the double chain to better match the motion of your foot. This means smooth movement at the bottom of the stroke with an accelerated PUSH at the top, and quick rebound for reactive doubles.

P1030R ELIMINATOR SOLO: RED

DRIVE	Sprocketless Double Chain
FOOT BOARD	Brushed Aluminum
POWERSHIFTER	Three Position
BEATER ANGLE	Uni-Lock Infinitely Adjustable
ROLLER HOOP CLAMP	Side Mount Adjustment
TENSION ADJUSTMENT	Click-Lock
BEATER	Control Core QuadBeater



Eliminator Solo: Red Double Pedal P1032R

Eliminator Solo: Red P1030R



CONTROL CORE QUADBEATER
Provides four beater surfaces (two hard plastic, two felt) with the added feel of the vibration-free Control Core elastomer center.
U.S. Patent #7626108



UNIVERSAL JOINT
All Eliminator Solo pedals come with Pearl's adjustable Universal Drive Joint, giving the secondary pedal the feel, power, and unrestrained feel of the main pedal.

P930/P932 PEDALS

Speed and Control for the Masses

SUPER SMOOTH, EXTREMELY FAST!

Merging quick rebound response of our flagship Demon Drive with the finely-tuned control of our award-winning Eliminator models, the P930 bass drum pedal offers high end performance at a player accessible price. Its longboard playing deck delivers a lighter feel for increased speed, and offers advanced performance control and tunability with two rotor cam options. The ultimate pedal for fast feet on a budget.

P930 BASS DRUM PEDAL		P932 DOUBLE BASS DRUM PEDAL	
DRIVE	Single Chain Drive	DRIVE	Single Chain Drive
DRIVE CAM	Perfect Circle Cam w/ Removable Eliminator-style Progressive Cam	DRIVE CAM	Perfect Circle Cam w/ Removable Eliminator-style Progressive Cam
FOOTBOARD	Demon Style Long Board	FOOTBOARD	Demon Style Long Board
BEATER	Control Core DuoBeater	BEATER	Control Core DuoBeater
BEATER ANGLE	Infinitely Adjustable	BEATER ANGLE	Infinitely Adjustable
SPRING TENSION	Click-Lock	UNIVERSAL JOINT	Length and Position Adjustable

Single Pedal Complete	P930
Double Pedal Complete (right footed)	P932
Double Pedal Conversion Kit (right footed)	P931
Double Pedal Complete (left footed)	P932L



The P930 pedal is included as an upgrade in the 830 Series hardware pack and comes with Export and Export Lacquer drum sets.

Single Pedal Complete
P930

2 POSITION
POWERSHIFTER
FUNCTION

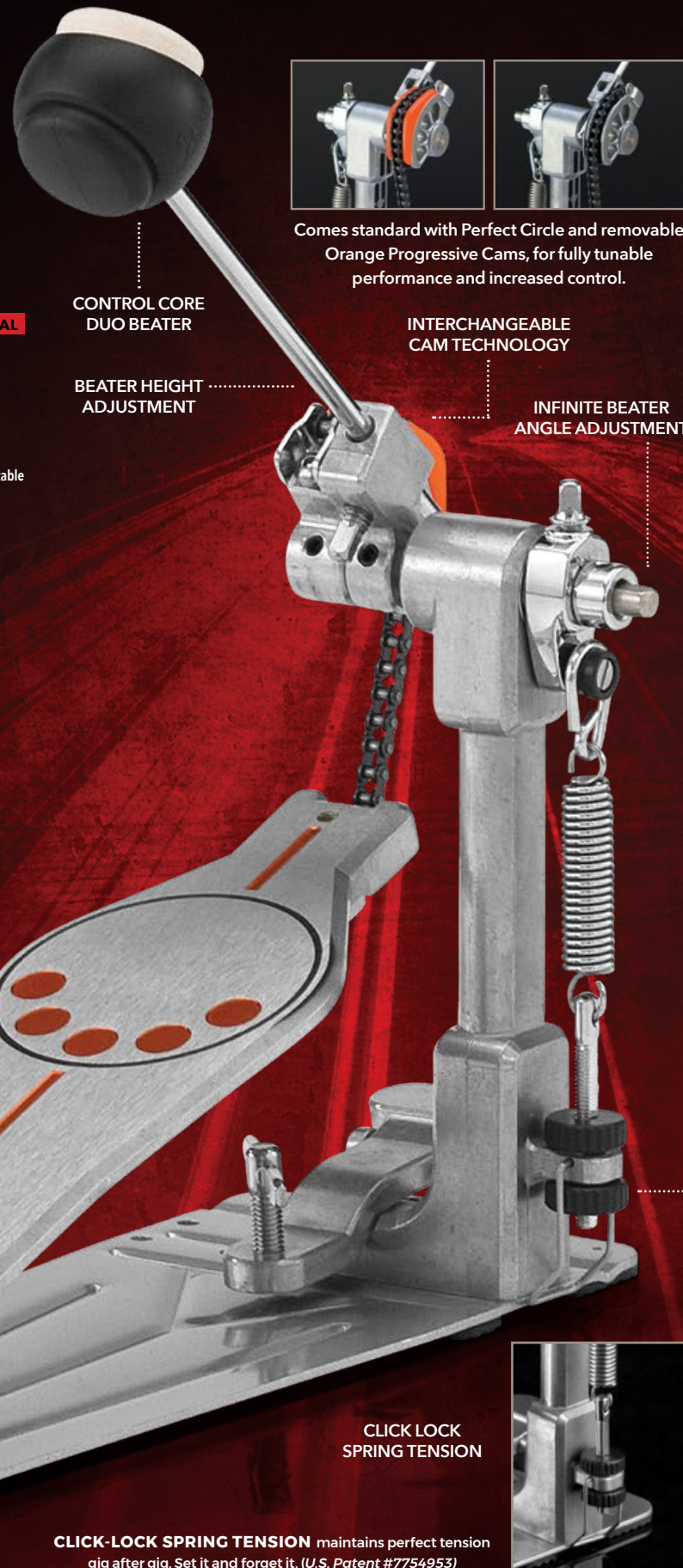

CLICK-LOCK SPRING TENSION maintains perfect tension gig after gig. Set it and forget it. (U.S. Patent #7754953)

CLICK LOCK
SPRING TENSION



Comes standard with Perfect Circle and removable Orange Progressive Cams, for fully tunable performance and increased control.

INTERCHANGEABLE
CAM TECHNOLOGY

CONTROL CORE
DUO BEATER

BEATER HEIGHT
ADJUSTMENT

INFINITE BEATER
ANGLE ADJUSTMENT



P932 DOUBLE PEDAL COMPLETE

Double the speed, power and control with the P932 Double. Give your feet the gift of speed at a fraction of the cost of other "less innovative" pedals.

Double Pedal Complete
P932

ORANGE PROGRESSIVE CAM can be removed to reveal the Perfect Circle for further tunability to match your playing style. (U.S. Patent #6172291)

CONTROL CORE DUO BEATER (U.S. Patent #7626108) utilizes an elastomer center to minimize vibration and features two unique playing surfaces (rounded felt and convex hard plastic surface) for quick-shifting tone and feel.

POWERSHIFTER FUNCTION (U.S. Patent #5574237) further tunes the power, feel, and leverage of the pedal by shifting the chain angle forward for lighter feel, or back for increased power.

Speed, Power, and Value P530 / P830



P530	
DRIVE	Sprocketless Double Chain
DRIVE CAM	Round/Linear Action
FOOTBOARD	Standard Length
BEATER	DuoBeat Two-Surface (Hard Plastic/Felt.)
HOOP CLAMP	Side Tension

Single Pedal Complete
P530

P530 DRUM PEDAL

With all the speed and function of a pro bass drum pedal at half the price, Pearl's P530 Bass Drum Pedal features a dual chain and Linear Action cam drive for smooth, traditional pedal action and speed. The radius rod frame makes it highly portable for gigging, while features like a two surface DuoBeater and rotor tension axle clamp make it adaptable to virtually any feel or playing style.

P830	
DRIVE	Single Chain
DRIVE CAM	Perfect Circle
FOOTBOARD	Demon Style Longboard
BEATER	DuoBeat Two-Surface
BEATER ANGLE	Infinitely Angling
SPRING ROLLER	Nylon

Single Pedal Complete
P830

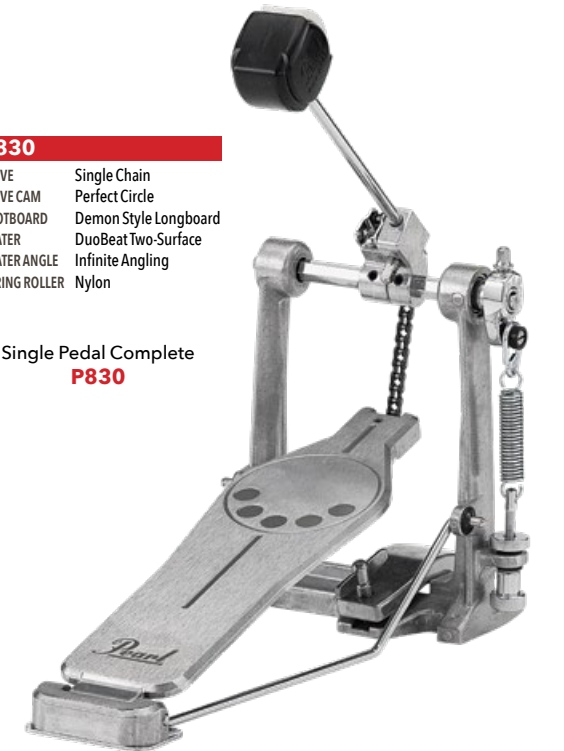

P830 DRUM PEDAL

Light in weight but not in features, the P830's Demon-style longboard increases playing surface for maximum leverage and speed. Its fully adjustable beater angle, Perfect Circle single chain cam, and DuoBeat two-surface beater deliver customizable feel for the player on the move.

HI-HAT STANDS

Biggest Advancement In Time-Keeping Since The Wristwatch

Sharing many of the key characteristics of Pearl's Eliminator Redline bass drum pedals, 2050 Series Hi-Hat Stands deliver unparalleled versatility and customization in hi-hat pedal control. The world's-only hi-hat stand featuring the Interchangeable Cam System, 2050 Series stands' customizable options are designed to eliminate resistance, reduce fatigue, and increase performance.

"Night in and night out, Pearl hardware keeps everything right where it should be, and without fail!"
- OKWA ANDREWS

BRIAN FRASIER-MOORE
Justin Timberlake / Pink

OKWA ANDREWS
Brian's Tech



CLA130
Closed Hi-Hat
Bass Drum Hoop Mounted
Side-to-Side,
Forward/Back Adjustable
Ultragrip Wingnut
Spring Adjustable
Cymbal Spread



CLH930
Closed Hi-Hat
Uni-Lock Tilter
Knurled Boom Arm
UltraGrip Wing Nuts
/ Wing Bolts



CLH70
Closed Hi-Hat
Multi-Angle Quickset Clamp
Gearless UniLock Tilter
Ultragrip Wingnut
Spring Adjustable Wash

Pearl's Rapid Lock Super Grip's slip-proof clutch system features a patented 360° lock nut that provides vice-like clamping force for a super grip.
(U.S. Patent #9355625)

H2050



RH2050

The RH2050 Remote Hi-Hat's low-friction cable produces smooth, lag-free performance with the lightning-fast action of the PosiLink Twin Cam drive system. Fast, natural-feeling cymbal play is finally accessible virtually anywhere on the kit, or to facilitate multiple hi-hat system setups.



H1050



Features Eliminator Solo traditional footboard, double braced swiveling tripod, and gigging weight tubing for touring professionals.

Features Eliminator Solo traditional footboard, single braced swiveling tripod, and reduced weight for gigging professionals.

Features an independent tripod positioned separately from the pedal frame, making it the only flat based hi-hat stand specifically for double pedals.



H2050

Rapid Lock Super Grip Clutch (U.S. Patent #9355625)
Hi-Hat Cup (U.S. Patent #7078606)
Swiveling Legs
Precision Spring Tension Dial
PosiLink Twin Cam Drive System with Interchangeable Cams
Traction Plate Footboard Convertible Spike/Rubber Feet
(U.S. Patent #7371953)
Footboard Docking Station
PowerShifter
Height Range of 750 - 1030mm

RH2050

Rapid Lock Clutch (U.S. Patent #9355625)
Direct Pull Drive System
Infinitely Adjustable Footboard Angle
Double Braced Tripod w/ Swivel Function
Spike/Rubber Tips
Spring Tension Dial
Hi-Hat Cup (U.S. Patent #7078606)

H1050

Rapid Lock Clutch (U.S. Patent #9355625)
Direct Pull Drive System
Infinitely Adjustable Footboard Angle
Double Braced Tripod w/ Swivel Function
Spike/Rubber Tips
Spring Tension Dial
Hi-Hat Cup (U.S. Patent #7078606)
Height range of 700 - 960mm

H1030

Direct Pull Drive System
Precision Spring Tension Dial
Double Braced Tripod w/ Swivel Function
SureGrip Oversize Rubber Feet
Smooth Traditional Footboard
Height range of 760 - 940mm

H1030S

Direct Pull Drive System
Precision Spring Tension Dial
Single Braced Tripod w/ Swivel Function
Smooth Traditional Footboard
Height range of 760 - 940mm

H930

Direct Pull Drive System
Precision Spring Tension Dial
Double Braced Tripod w/ Swivel Function
SureGrip Oversize Rubber Feet
Demon Style Long Board Footboard
Height range of 760 - 940mm

H830

Demon Style Long Footboard
(Single Color Footboard)
Double Braced Tripod w/ Swivel Function
Height range of 610 - 910mm

H150S

Light Weight (6.30 lbs.)
Stable Flat-Based Tripod
Swivel Function Allows Easy
Double-Pedal Positioning
Direct-Pull Drive System
Spring Tension Adjustment
Redline Traction Plate Footboard
Height range of 745 - 865mm



INDEPENDENT TRACTION GRIPS Features Pearl's exclusive reversible Traction Plate and individual traction grips, configurable to suit your individual taste.



H2050 PRECISION SPRING TENSION DIAL Allows perfect tension control for fine-tuned response.



H1050 PEDAL HEIGHT ADJUSTMENT The infinite footboard angle adjustment featured on the H2050 and H1050 allows precise height matching in multi-pedal setups.



CLAMSHELL CLAMP The H2050, H1050, H1030, H1030S, and H930 Hi-Hat Stand uses beefy 1" tubing and clamshell clamps with built in memory locks for superior rigidity.



H130 Positions your hi-hat next to your bass pedal in double bass set-ups for effortless transitions between pedals.



H930 HI-HAT STAND H930 Hi-Hat Stand features our Demon style longboard, double braced tripod w/ swivel function, and precision tension dial.



H830 HI-HAT STAND H830 Hi-Hat Stand is standard equipment with our Export series and offers a monochromatic Demon Style longboard design and swivel tripod.



H150S* FLAT-BASED SWIVELING HI-HAT The H150S independent tripod is positioned separately from the pedal frame making it the only flat-based hi-hat stand with swiveling legs.
**Toe Stopper Not Included*

SNARE STANDS

No matter the gig or the drum, Pearl has a stand to accommodate both with security, high function, and chameleon-like diversity.



Every Snare Should Be So Lucky



S1030



S1030D



S930

S1030
GyroLock Tilter: Infinite Angle Adjustability
Adjustable Snare Basket: Fits Snares 10" - 16"
Air Suspension Rubber Tips
Trident Tripod
Height Range of 480 - 700mm
Oversize Super Grip Rubber Feet

S1030D
Low Position Snare Stand (Height Range: 310 - 520mm)
GyroLock Tilter: Infinite angle adjustability
Adjustable Snare Basket: Fits 10" to 16" drums
Air Suspension Rubber Tips
Trident Tripod
Oversize Super Grip Rubber Feet

S930
Uni-Lock Tilter
Air Suspension Rubber Tips
Double Braced Trident Style Tripod
Fits Snares 10" - 14"
Height Range of 470 - 670mm
S930S drop basket version also available



S1030 SNARE STAND GYROLOCK Our premier S1030 model features Pearl's 360 degree infinitely adjustable GyroLock tilter for ease-of-use and pinpoint positioning.



S1030 SNARE BASKET The Pearl S1030 Snare Stand adjusts to fit virtually any size snare from 10" to 16". The Air Suspension rubber tips securely cradle your prized snares while allowing them to fully resonate.



S930D SNARE BASKET The S930D Snare Stand is a shorter version of the S930 Snare Stand, and is built to comfortably accommodate deeper snare drums.



SPIKED / RUBBER FEET (Sold Separately)
Our CVT300/3 Push Button Spiked/Rubber Feet come in pack of 3 to retrofit on any of our 1030 Series hardware for sure-footed performance on any terrain. (U.S. Patent #7371953)



S930D



S930S



S830



S150S

S150S Convertible Tripod Base

S930D
Uni-Lock Tilter
Air Suspension Rubber Tips
Double Braced Trident Style Tripod
Fits Snares 10" - 14"
Height Range of 360 - 570mm

Drop basket for deeper snares

S930S
Uni-Lock Tilter
Air Suspension Rubber Tips
Single Braced Trident Style Tripod
Fits Snares 10" - 14"
Height Range of 420 - 610mm

S830
Uni-Lock Tilter
Double Braced Tripod
Fits Snares 13" - 14"
Height Range of 440 - 650mm

Standard with Export Series drums, perfect for local gigging and easy transport

S150S
Light Weight (5.18 lbs.)
Stable Flat-Based Tripod
Gearless Uni-Lock Basket Tilter
Convertible Tripod or Flat-Based Legs

Instantly convertible from flush-based to standard tripod

DRUM THRONES

Sound Ergonomics

MULTI-CORE FOAM TECHNOLOGY: Roadster thrones now feature multiple layers of varied density foam which combine for a better playing foundation and improved feel.



D3500BR



D3500



D1500TGL



D1500RGL

D3500BR
Saddle-Style, Multi-Core Foam Cushion
Detachable Backrest Mounts via Single Knob
Lock/Spin System: Reversible StopLock allows cushion to be secured in place or free spinning depending on preference
Height Range of 495-665mm

D3500
Saddle-Style, Multi-Core Foam Cushion
Accepts Optional Backrest
Lock/Spin Reversible StopLock System
Height Range of 495 - 665mm

D1500TGL
15" Trilateral Multi-Core Foam Cushion
Option of a Saddle or Round top feel
Accepts Optional Backrest
Gas Lift Height Adjustment
Lightweight Aluminum Struts:
Solid support with easier transport
Height Range of 495 - 695mm

D1500RGL
15" Round Multi-Core Foam Cushion
Accepts Optional Backrest
Gas Lift Height Adjustment
Lightweight Aluminum Struts
Height Range 495 - 695mm



D1500SP



D1500



D1500S



DTBR1535

D1500SP
15" Vented Round Seat
Multi-Core Foam Donut Cushion
Accepts Optional Backrest
Built-In Shock Absorber Post
w/ Adjustable Spring Tension
Lock/Spin Reversible StopLock System
Height Range of 525 - 630mm

D1500
15" Vented Round Seat
Multi-Core Foam Donut Cushion
Accepts Optional Backrest
Lock/Spin Reversible StopLock System
Height Range 495 - 665mm

D1500S
15" Vented Round Seat
Multi-Core Foam Donut Cushion
Accepts Optional Backrest
Lock/Spin Reversible StopLock System
Height Range 445 - 615mm

DTBR1535
12.5" x 7" Optional Backrest
Formfitting and Breathable
Removable
Dual Axis Adjustability



D930



D790



D730S



D50

D930
Round Vinyl Cushion
Double Braced Legs
Height Range of 470 - 660mm

D790
Round Vinyl Cushion
Double Braced Legs
Height Range of 430 - 650mm

D730S
Round Vinyl Cushion
Single Braced Tripod
Height Range of 405 - 605mm

D50
Round Vinyl Cushion
Double Braced Tripod
Height Range of 495 - 620mm

CYMBAL STANDS

FOR EVERY CYMBAL, THERE IS A PLACE.

Advancing Drum Hardware for Serious Working Drummers since 1946. Through constant setup, teardown, performance, practice, and transport, Pearl has you covered with cymbal stand solutions that are ready to endure constant abuse and keep going.

Welcome to Boom Town

“ Pearl hardware is literally the only hardware that you’ll ever have to buy and it’s all backed by their incredible lifetime warranty! ”

- TRACY BROUSSARD

TRACY BROUSSARD
Blake Shelton



CLAMSHELL designed Die Cast joint on 2030, 1030, 930 series Boom and Straight cymbal stands, provides superhuman clamping force. Set your position, lock it down and wail away.

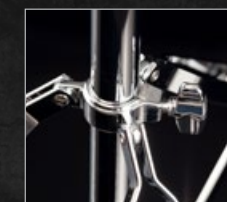

830 SERIES STANDS offer lighter weight while incorporating many of the 1030 series designs. The tripod uses Trident style design with double braced legs. Large easy to use wingnuts and lateral struts for optimal stability.

The most technically advanced boom stand ever devised. Perfect for studio or live applications.

BC2030

Reversible Felt/
Foam Washer.



B1030C



B1030



BC930



BC2030
GyroLock Tilter
WingLoc
Reversible Cup Washer w/ O-ring
Die Cast Joint w/ Stop Lock
Trident Tripod
Double Braced Legs
Built in Percussion Post
Nodal Point Resonance Enhancing System
Height Range of 800 - 2150mm

B1030C
GyroLock Tilter
WingLoc
Reversible Cup Washer w/ O-ring
Convertible Boom Tilter
Trident Tripod
Double Braced Legs
Reversible Felt/ Foam Washer
Height Range of 820 - 1900mm

B1030
GyroLock Tilter
WingLoc
Reversible Cup Washer w/ O-ring
Die Cast Joint
Trident Tripod
Double Braced Legs
Built in Percussion Post
Reversible Felt/ Foam Washer
Height Range of 820 - 1900mm

BC930
Uni-Lock Tilter
Plastic Wingnut
Plastic Cymbal Cup
Die Cast Joint
Trident Style Tripod
Convertible Boom Tilter
Double Braced Leg
Height Range of 830 - 1800mm

Reduced weight for easy gigging transport.

BC930S



Offers lighter weight with advanced appointment designs.

BC830



BC820



BC150S

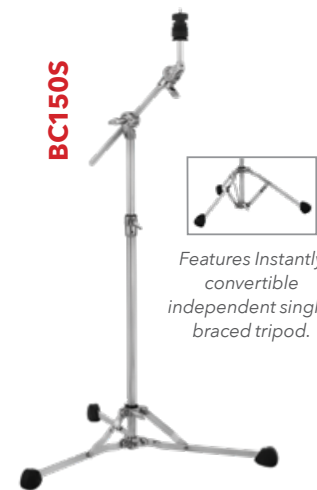

Features Instantly convertible independent single-braced tripod.

BC930S
Uni-Lock Tilter
Plastic Wingnut
Plastic Cymbal Cup
Die Cast Joint
Trident Tripod w/ Single Braced Legs
Convertible Boom Tilter
Height Range of 780 - 1800mm

BC830
Uni-Lock Tilter
Plastic Wingnut
Plastic Cymbal Cup
Die Cast Joint
Convertible Boom Tilter
Double Braced Legs
Height Range of 780 - 1480mm

BC820
Uni-Lock Tilter
2 Section Stand
Plastic Wingnut
Plastic Cymbal Cup
Die Cast Joint
Convertible Boom Tilter
Double Braced Legs
Height Range of 900 - 1740mm

BC150S
Light Weight (5.42 lbs.)
Uni-Lock Tilter
Convertible Single-Braced Tripod
Convertible Boom Tilter
Plastic Wingnut and Cymbal Cup
Reversible Felt/ Foam Washer
Height Range of 780 - 1300mm

Solid. Stable. Professional.

C1030



Exceptional stability for gigging and touring.

C930



Built for rigid support and light transport.

C930S



Offers lighter weight with advanced appointment designs.

C830



Features Instantly convertible independent single-braced tripod.

C150S



C1030
GyroLock Tilter
WingLoc
Reversible Cup Washer w/ O-ring
Die Cast Joint
Trident Tripod
Double Braced Legs
Height Range of 770 - 1530mm

C930
Uni-Lock Tilter
Plastic Wingnut
Plastic Cymbal Cup
Die Cast Joint
Trident Style Tripod
Double Braced Legs
Height Range of 760 - 1500mm

C930S
Uni-Lock Tilter
Plastic Wingnut
Plastic Cymbal Cup
Die Cast Joint
Trident Tripod
w/ Single Braced Legs
Height Range of 780 - 1480mm

C830
Uni-Lock Tilter
Plastic Wingnut
Plastic Cymbal Cup
Die Cast Joint
Double Braced Legs
Height Range of 720 - 1480mm

C150S
Light Weight (4.80 lbs.)
Uni-Lock Tilter
Convertible Single-Braced Tripod
Plastic Wingnut and Cymbal Cup
Reversible Felt/ Foam Washer
Height Range of 670 - 1350mm

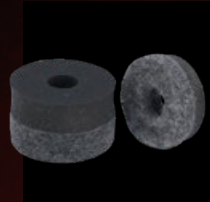

REVERSIBLE FELT / FOAM CYMBAL WASHERS allow four-way control of cymbal "ring" by mixing and matching the "hard" and "soft" surfaces of the washers.

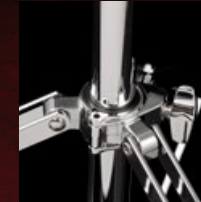

THE TRIDENT TRIPOD uses a full 360° of clamping force via the hinged collar. The inner tube rests in a nylon bushing to prevent metal to metal contact. Heavy duty legs feature lateral bracing for superior ultra quiet rigidity.



REVERSIBLE CUP WASHER w/ O-RING (U.S. Patent #6940006) Specially designed to "float" normally or "lock" to prevent noise during recording.

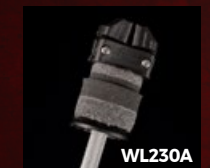

WL230A



WL230A

WINGLOC Quick Release Wing Nut (U.S. Patent #6884015) Secure, adjustable, spring loaded cymbal nuts for quick set up and tear down.



NODAL POINT MARKINGS Pearl's BC2030 features markings on the telescopic tubes that allow cymbals to achieve better clarity and sustain when the tubes are positioned at their respective Nodal Points. (U.S. Patent #9070348)

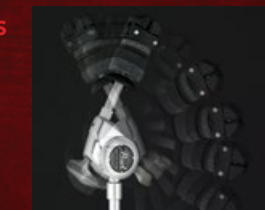

GYROLOCK TILTERS are infinitely adjustable and provide 360 degree range of motion for precise positioning with one-step convenience.

ICON RACK SYSTEM

The Original Drum Rack, Expanded

RACKS Preconfigured single and three-sided rack packages with rotating support feet.



EXPORT LACQUER
#222 Gloss Tobacco Burst



MASTERWORKS SERIES STUDIO SHELL RECIPE
in Gloss Natural Artisan Sycamore with Ebony inlay & Black Nickel Hardware

MASTERWORKS SERIES with ICON RACK & e/MERGE
in Black Sparkle Burst to Granite Sparkle & Black Nickel Hardware



Developed in 1983 with legendary Toto drummer Jeff Porcaro, Pearl's original DR1 Drum Rack was the first freestanding, frame based drum support system available.

Now, Pearl expands the **ICON** (short for **I**ndependent **CON**trol) Rack system with a fresh selection of upgrades and high function mounting options.

3-Sided Rack
(*also available DR008 Expansion Bar)
DR80

DR80	
INCLUDES	(4) PC8 Pipe Clamps
RACK BAR	Black Anodized Aluminum 38mm Square, 91cm Length
RACK LEG	Black Anodized Aluminum 1.5" Diameter, 70.5cm Height



Three-Sided Drum Rack, Straight
(w/ PCX100X4 & PCL100X2)
DR513

DR513	
RACK RAILS	Pearl 40mm Square Anodized Aluminum
SUPPORT LEGS/FEET	38"x2.5" Round Chrome w/ P38475TA Rotating Foot
INCLUDED RAIL CLAMPS	4 PCX100
INCLUDED PIPE CLAMPS	2 PCL100
USABLE RAIL AREA	36" (38" from Center of Right to Left Clamp)



Three-Sided Drum Rack, Curved
(w/ PCX100X4 & PCL100X2)
DR513C

DR513C	
RACK RAILS	Pearl 40mm Square Anodized Aluminum
SUPPORT LEGS/FEET	38"x2.5" Round Chrome w/ P38475TA Rotating Foot
INCLUDED RAIL CLAMPS	4 PCX100
INCLUDED PIPE CLAMPS	2 PCL100
USABLE RAIL AREA	36" (38" from Center of Right to Left Clamp)



Single Drum Rack, Straight
(w/ PCX100X2 & PCL100X2)
DR511

DR511	
MAIN SUPPORT RAIL	Brushed Aluminum, 40mm Square
MOUNTING CLAMPS	PCX100 Clamps (x2) Fits 1/2" to 1 1/8"
RACK RAIL LENGTH	38" (From Center of Right to Left Clamp) 36" (Usable Area)
RACK PIPE/LEG	Steel 1.5" / 3.8cm Diameter, 34" / 86.5cm Height
SUPPORT FOOT	Rotating 1.5" Round w/ TLJ200 T-Clamp (P38475TA)
PIPE CLAMPS	PCL100 (x2) Accepts 7/8" Diameter Arms



Single Drum Rack, Curved
(w/ PCX100X2 & PCL100X2)
DR511C

DR511C	
MAIN SUPPORT RAIL	Brushed Aluminum, 40mm Square
MOUNTING CLAMPS	PCX100 Clamps (x2) Fits 1/2" to 1 1/8"
RACK RAIL LENGTH	46" (From Center of Right to Left Clamp) / 44" (Usable Area)
RACK PIPE/LEG	Steel 1.5" / 3.8cm Diameter, 34" / 86.5cm Height
SUPPORT FOOT	Rotating 1.5" Round w/ TLJ200 T-Clamp (P38475TA)
PIPE CLAMPS	PCL100 (x2) Accepts 7/8" Diameter Arms



Straight Drum Rack Expansion Bar
w/ Support Leg
DR511E

DR511E	
RACK RAIL	Pearl 40mm Square Anodized Aluminum
SUPPORT LEG/FOOT	34"x2.5" Round Chrome w/ P38475TA Rotating Foot
USABLE RAIL AREA	36" (38" From Center of Right to Left Clamp)



Curved Drum Rack Expansion Bar
w/ Support Leg
DR511CE

DR511CE	
RACK RAIL	Pearl 40mm Square Anodized Aluminum
SUPPORT LEG/FOOT	34"x2.5" Round Chrome w/ P38475TA Rotating Foot
USABLE RAIL AREA	44" (46" From Center of Right to Left Clamp)



Drum Rack Moveable Support T-Leg
DR110T

DR110T	
SUPPORT LEG/FOOT	34"x2.5" Round Chrome w/ P38475TA Rotating Foot

RACK ACCESSORIES

An Industry Icon - The Professional's Choice

TOM STANDS/ARMS

Positioning Possibilities Never Before Attainable

Our T/TC1030 Series features our GyroLock tilter for an infinite 360 degree range of movement. The T/TC930 Series use our Uni-Lock tilter for 180 degrees of motion. Our TH88 and TH70 Tom Arms Series use our dependable gear tilter.



GYROLOCK



UNI-LOCK



GEAR TILTER

ICON RACK RECIPES

Check out Pearl's ICON Rack Recipe videos at www.pearlrackrecipes.com for step-by-step instructions on how to get the most from existing and available Pearl Rack parts.

MOUNTING CLAMPS

Developed for the slip resistant ICON square rack rail and round support pipe. Each dramatically increases the level of setup flexibility and function variety.



Expandable Pipe Clamp Fits All Icon Rack Leg Posts
PCL100

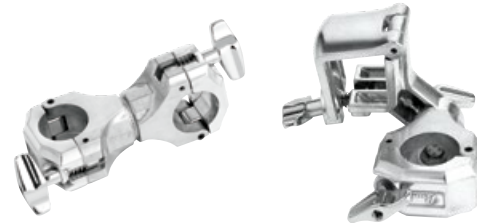

Dual Pipe Clamp
PCR100

Pipe To Rail Clamp
PCR200



Pipe To Rail Clamp
PCR200L



Rotating Pipe Accessory Clamp
PCR50X



Pipe Accessory Clamp
PCR50L



Rotating Dual Pipe Clamp
PCR50R



Curved Rack Rail Short w/ Clamp
AL86AC



Curved Rack Rail Medium w/ End Caps
AL103A



Icon Support Foot w/ TLJ200 T-Clamp
P38475TA



Rail Accessory Clamp System w/ Adjustable Jaw
PCX100



Rotating Rail Accessory Clamp/Tilting Clamp System w/ Adjustable Jaw
PCX200



Extended Rotating Rail Accessory Clamp
PCX300



Pipe Clamp Fits 7/8" tubes, for DR80
PC8



Icon 6" Mini-Expansion Bar
RJ50



Pipe Joint
RJ100



2 Clamps Fits 5/8" to 1-1/8" **ADP20***

2 Revolving Clamps Fits 1/2" to 1-1/8" **AX25***

2 Revolving Clamps Fits 1/2" to 1-1/8" **AX25L***

In-Line & Revolving Clamps Fits 5/8" to 1-1/8" & 1/2" to 1-1/4" **AX28***

3 Adjustable Clamps Fits 3/8" to 1-1/4" **ADP30***



T1030



T930



TC1030B



TC930



CHB75CA



CHB75LB



CH1030B



CH930



CH830



Mic Holder
MH830



TH1030



TH1030S

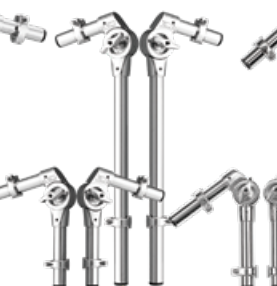

TH1030I

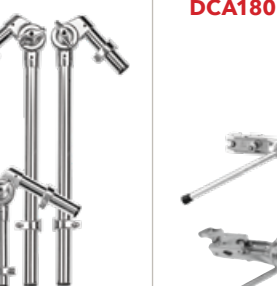

TH900S



TH900I



TH88S

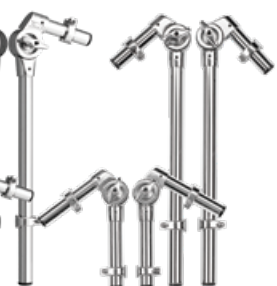

TH88I



TH70S

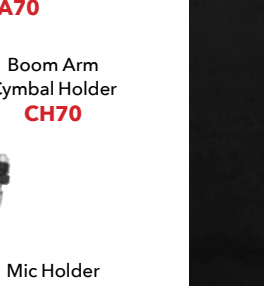

TH70I



CH1030BS

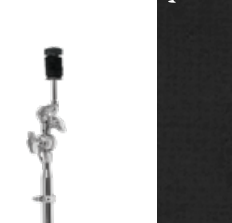

CH930S

CH830S



Boomerang Curved Boom Arm with Clamp and Tilter
CHC200



Boomerang Curved Cymbal Boom Arm
CHC100



Two Way Arm & Leg Cymbal Adapter (shown w/ DC180)
DCA180



Boom Arm Cymbal Holder
CH70



Mic Holder
MH70A



UX80S **UX80**

Features rotating infinitely adjustable clamps for multiple uses.

13" Tube Height Extender
TX100

Accepts 7/8" dia. tubes. Ideal for extending snare stand height.

Tube Extender for 1" Pipe
TX125

Accepts 1" dia. tubes. Ideal for extending travel conga stands.



Chrome Multi Bass Drum Legs
PMBDL3/C

Multi-Bass Drum Legs allow any bass drum to be played horizontally. Height and tilt adjustable.



Bass Drum Mount Cymbal Holder
CHB830

Mounts directly to the bass drum.

PEARL PERCUSSION ARTISTS



AARON DRAPER
John Mayer / Eminem / Adele

ALAIN PEREZ
Alain Perez

ANDY FARAG
Umphreys McGee

ARCHIE PENA
Shakira

BOBBY ALLENDE
Tito Nieves

BRETT BAKER
Rihanna / Jay-Z



CAMILO QUINONES
El Dusty

CARLITO SOTO
Willie Colon

CARLITOS PADRON
Rumberos Del Callejon

CESAR ESPINOZA
Orchestra Tobaco Y Ron

COLIN DOUGLAS
Aerosmith

CHRISTIAN PEPIN
Independent



DIMAS SANCHEZ
Fusion Beat / Trilogy Latin Jazz

DOMINIQUE THOMAS
John Legend / Jill Scott

EMRAH KOTAN
Independent

ETIENNE FUENTES
Independent

HORACIO HERNANDEZ
Independent

JESSIE CARABALLO
Marc Anthony



JESUS DIAZ
Independent

JOSE ROSA
Independent

LALO DAVILA
MTSU

MARC QUIÑONES
The Doobie Brothers

MARCO "ITO" ARGUINZONI
Independent

MARVIN DIZ
Independent



OG
Slightly Stoopid

OMAR LEDEZMA
Independent

PAPO PEPIN
N.Y. Conga Legend

RAFA PEREIRA
Janelle Monae

RAVI JAKHOTIA
Ravi Drum

ROBERTO VIZCAINO JR.
Orquesta Akokan



ROLANDO MORALES MATOS
The Lion King / Curtis Institute

SAMMY FIGUEROA
Master Percussionist

SAMMY GARCIA
Independent

TRILOK GURTU
Independent

VALERIE DEE NARANJO
Saturday Night Live Band

ZIG WALJER
Hands-On With Zig

SIGNATURE SERIES

The Pros Play Pearl!

BOBBY ALLENDE FIBERGLASS CONGAS AND BONGOS

Bobby Allende is a mainstay in the New York Latin Music Scene and he demands the best from his drums, that's why he plays Pearl. His Signature drums are fiberglass with no seams to inhibit vibration which allow the drums to resonate freely for the full, rich sound that Bobby is famous for. The congas are 28 inches tall, fitting the traditional seated player perfectly while adding extra width to the base for added projection and stability. A matching set of bongos is also available.



#617 Confetti
Signature Fiberglass
Congas and Bongos



- SHELL Seamless Fiberglass
- HEADS Remo Fiberskyn3
- RIMS Low-Rider Contour Crown
- HARDWARE Brushed Steel
- FINISH #617 Confetti
- BONGOS PBF300DXBA
- OPTIONAL BAGS PSC110CG 11" Quinto Conga Bag
PSC117CGW 11.75" Conga Bag
PSC125CG 12.5" Tumba Conga Bag

The Bobby Allende congas and bongos feature Remo Fiberskyn 3 heads for tuning stability and Pearl's Low-Rider crowns with a radical sloping edge that practically disappears under your hands for comfort you have to experience to believe.

If you demand excellence like Bobby, check out his Signature Fiberglass Congas and Bongos.

- CONGAS
- PCF110DXBA617 11" QUINTO
- PCF117DXBA617 11.75" CONGA
- PCF125DXBA617 12.5" TUMBA

- BONGOS
- PBF300DXBA617 7" & 8.5"

JESUS DIAZ OAK CONGAS AND BONGOS

Cuban born Jesus Diaz is one of the most in demand percussionists and vocalists on the scene today. His active schedule provided the feature set for his signature series of congas and bongos. Designed for the seated player the Thai Oak drums measure 30" tall and from the Quinto to Tumba feature added girth to the belly of the drum. Seated conga players typically have to tilt the drum to achieve the desired projection, but the Jesus Diaz drums feature a 4" port on the front of the drum that is strategically positioned to deliver the maximum base frequency while the drum remains flat on the floor.



PHOTO: LISA KEATIN



#580 Brushed Platinum
Natural Buffalo Skin Heads

- SHELL Thai Oak
- HEADS Buffalo Skin
- RIMS Low-Rider Contour Crown
- HARDWARE Quick Release Lugs
Brushed Steel Finish
- FINISH #580 Brushed Platinum
- BONGOS PBW300DXJD
- OPTIONAL BAGS PSC110CG 11" Quinto Conga Bag
PSC117CGW 11.75" Conga Bag
PSC125CG 12.5" Tumba Conga Bag

The drums also feature a newly designed Quick Release lug that is slotted to allow removal of the tension rod without fully removing the nut. Player comfort was also an important ingredient in the design of the hoop. A new ergonomically friendly design reduces the impact to your hands while an internal ring centers the natural buffalo skin heads for accurate placement.

- CONGAS
- PCW110DXPD580 11" QUINTO
- PCW117DXPD580 11.75" CONGA
- PCW125DXPD580 12.5" TUMBA

- BONGOS
- PBW300DXJD580 7" & 8.5"

CONGAS & BONGOS

Tools of the Trade

ELITE SERIES

ELITE WOOD-FIBER CONGAS
PWFC110DX648 - 11" QUINTO
PWFC117DX648 - 11.75" CONGA
PWFC125DX648 - 12.5" TUMBA

SHELL Blended, Thai Oak over Fiberglass
 HEADS Natural Cow Skin
 RIMS Contour Crown
 HARDWARE Brushed Steel
 FINISH #648 Maduro Brown

ELITE WOOD-FIBER BONGOS
PWFB100DX648 - 7" & 8.5"

ELITE OAK CONGAS
PCW110DX504 - 11" QUINTO
PCW117DX504 - 11.75" CONGA
PCW125DX504 - 12.5" TUMBA

SHELL 100% Thai Oak
 HEADS Premium Natural Cow Skin
 RIMS Contour Crown
 HARDWARE Chrome
 FINISH #504 Mocha Burst

ELITE OAK BONGOS
PBW300DX504 - 7" & 9"



ELITE OAK CONGAS
PCW110DX510 - 11" QUINTO
PCW117DX510 - 11.75" CONGA
PCW125DX510 - 12.5" TUMBA

SHELL 100% Thai Oak
 HEADS Premium Natural Cow Skin
 RIMS Contour Crown
 HARDWARE Brushed Steel
 FINISH #510 Caramel Brown

ELITE OAK BONGOS
PBW300DX510 - 7" & 9"

ELITE OAK CONGAS
PCW110DX506 - 11" QUINTO
PCW117DX506 - 11.75" CONGA
PCW125DX506 - 12.5" TUMBA

SHELL 100% Thai Oak
 HEADS Premium Natural Cow Skin
 RIMS Contour Crown
 HARDWARE Chrome
 FINISH #506 Merlot Burst

ELITE OAK BONGOS
PBW300DX506 - 7" & 9"



ELITE FIBERGLASS CONGAS
PCF110DXA - 11" QUINTO
PCF117DXA - 11.75" CONGA
PCF125DXA - 12.5" TUMBA

SHELL Fiberglass
 HEADS Premium Natural Cow Hide
 RIMS Contour Crown
 HARDWARE Brushed Steel
 FINISH #641 Blue Sparkle Burst

ELITE OAK BONGOS
PBF300DXA - 7" & 9"



Also available in #532 Cherry Eucalyptus

ELITE OAK CONGAS
PCW110DXG - 11" QUINTO
PCW117DXG - 11.75" CONGA
PCW125DXG - 12.5" TUMBA

SHELL 100% Thai Oak
 HEADS Premium Natural Cow Skin
 RIMS Contour Crown
 HARDWARE Gold
 FINISH #535 Satin Black

ELITE OAK BONGOS
PBW300DXG - 7" & 9"

HAVANA SERIES

HAVANA CONGAS
PCF110HV - 11" QUINTO

PCF117HV - 11.75" CONGA

PCF125HV - 12.5" TUMBA

HAVANA BONGOS
PBF300HV - 7" & 8.5"



The wide belly shape of these high end, fiberglass drums produce deeper low tones and greater volume.

SHELL Fiberglass
 HEADS Natural Cow Skin
 RIMS Contour Crown
 HARDWARE Chrome
 FINISH #644 Liquid Gold

SHELL Fiberglass
 HEADS Natural Cow Skin
 RIMS Contour Crown
 HARDWARE Chrome
 FINISH #187 Silver White Swirl

SHELL Fiberglass
 HEADS Natural Cow Skin
 RIMS Contour Crown
 HARDWARE Chrome
 FINISH #651 Red Tiger Stripe

PRIMERO PRO

PRIMERO PRO FIBERGLASS

PRIMERO PRO OAK



11.75" & 12.5" Conga Set #628 Blue Marble
 Shown with matching bongos
PFC302DX628



10" & 11" Conga Set
 #621 Wine Red Marble
PFC202DX621



7" & 8.5" Bongos #523 Carbon Vapor
PWB100DX523 11.75" & 12.5" Congas
 #523 Carbon Vapor
PWC302DX523

PFC302DX626 #626 Gold Marble



Designed with professional features at an affordable price. Our expanded range of sizes offers 10" & 11" and 11.75" & 12.5" sets in both Thai Oak and Fiberglass with matching bongos.

PRIMERO PRO FIBERGLASS
PFC302DX (11.75" & 12.5" Conga Set)
PFC202DX (10" & 11" Conga set)

Offer added durability of fiberglass and are louder drums with a crisper sound than wood.

SHELL Fiberglass
 HEADS Buffalo Skin
 RIMS Contour Crown
 HARDWARE Brushed Steel
 FINISH #621 Wine Red Marble
 #626 Gold Marble
 #628 Blue Marble

PRIMERO PRO OAK
PWC302DX (11.75" & 12.5" Conga Set)
PWC202DX (10" & 11" Conga set)

Primero Pro wood congas are made with Thai Oak and produce a warm, rich tone.

SHELL Thai Oak
 HEADS Buffalo Skin
 RIMS Contour Crown
 HARDWARE Brushed Steel
 FINISH #511 Natural
 #521 Midnight Fade
 #523 Carbon Vapor

PRIMERO



10" & 11" Conga Set w/ PC300 Stand
PFC203602

Primero Series congas and bongos are available with fiberglass shells and in packages that include a double stand (PC300W) or without stands.



10" & 11" Conga Set
PFC202602

SHELL Fiberglass
 HEADS Buffalo Skin
 RIMS Contour Crown
 HARDWARE Black Powder Coat
 FINISH #602 Bistre Black

FIELD PERCUSSION



Weather resistant fiberglass body that delivers a thunderous low-end tone. Remo Nuskyn heads.

10" & 11" Congas
 #649 Textured Black
PFC202EDU649

CONGA RESO-PLATE



Designed for the seated conga player, Pearl's Reso-Plate will give you that hard surface desired for maximum resonance. Configured with a cutout handle, the plates can also easily be placed on top of your drums for extra protection when packed in your conga case.

Conga Reso-Plates
PRP140

TRAVEL

Congas, Bongos, & Timbales



Where can you take the Pearl Travel Congas and Bongos? The answer is anywhere you can take traditional drums but without any of the hassle. The Travel Congas feature a 3.5" deep wood shell with stave construction and Remo Symmetry heads. Available in three sizes: 11" x 3.5", 11.75" x 3.5" and 12.5" x 3.5" each with five precision Allen bolts. The 7" and 8.5" Travel Bongos feature 3.5" Thai Oak shells with Remo Fiberskyn heads and three point tuning. The Travel Conga and Bongos include a foam-handle tuning wrench.

CONGAS



11.75" Travel Conga
#510 Caramel Brown
PTC1175N

12.5" Travel Conga
#510 Caramel Brown
PTC1250N

11" Travel Conga
#510 Caramel Brown
PTC1100N



Travel Conga Bag
PSC1175TC



Travel Bongos Bag
PSC785TB

The optional Travel Conga Stand works with all three size drums and features a tension lever mounting system that locks the drum into place. The wide based, double braced legs provide a solid foundation for your drum and prevents the stand from moving during performance.

BONGOS



Travel Bongos
#510 Caramel Brown
PTB785



Travel Conga Stand
w/ Carrying Bag
PC800TC



Travel Bongos Stand
PC800TB
PC800TBS (Short)



TIMBALES



Travel Timbales 14" & 15"
with Stand*
PTTM1415

*Bag sold separately



The Pearl Travel Timbales feature 14" and 15" steel shells that are professional size in diameter but only 4" deep.



The drums are connected by a hinge that marries them to the Quick Release stand. The custom hinge allows the drums to be folded together into the size of one standard depth timbale for easy storage and transportation.



The Travel Timbales come with a single braced stand that includes an 11.25" adjustable accessory post with 6 positions that allow cowbells and blocks to be placed the perfect distance from the player.

The steel shells feature a black lacquer finish and USA Remo clear Ambassadors heads for a truly professional sounding instrument. A soft carrying case for the stand is also included (sold separately).

TIMBALES

MARC QUIÑONES
Doobie Brothers



MARC QUIÑONES
SIGNATURE TIMBALES

BANDA SERIES



Banda Timbales
15"x10" / 16"x10" Steel w/ Tilting Stand
PBTM1516/C



Primero
13"x7" Steel Timbale
w/ PPS36 Mount
PTE1336



Flat Timbale w/ I.S.S.
13"x3" Steel
PTE3131



Flat Timbale w/ I.S.S.
13"x3" Brass
PTB3131



Tilting Timbale
Stand (Short)
Height Range
26.5" to 36.5"
PT900WS



Marc Quiñones
Signature Timbales
14"x7" / 15"x7" Steel
w/ PT900 Tilting Stand
and PBL30 Clave Block
(Cowbell Not Included)
ETE1415MQ



Primero Timbales
13"x6.5" / 14"x6.5" Steel
w/ PT900 Tilting Stand
(Stands & Cowbell Included)
PTS5134



Primero Pro Timbales
14"x7" / 15"x7" Steel
w/ PT900 Tilting Stand
(Sticks Included,
Cowbell Not Included)
PTE1415DX

COWBELLS

Pearl and Grammy Award winning artist Horacio Hernández have developed the ultimate family of cowbells. The HH4XH bell features a quick release system that allows the bell to lift easily off of its mount for hand held playing.

HORACIO HERNÁNDEZ
Latin Legend



Marybell **HH5** Hand-Held Campana Quick Release **HH4XH** Isabell Mambo Bell **HH4** Chabella **HH3** Clabell **HH2** Bella **HH1**

AGOGO & TRIBELLS



Tri-Bells **PTB30** Hand-Held Agogo **ECB22** Mounted Agogo **ECB23**

NEW YORKER BELLS



Cha-Cha (High) **BCM3NY** Cha-Cha (Low) **BCM5NY** Mambo **BCM7NY** Marc Quiñones Sig. Timbale Bell **BCM8NYQ**

BALA BELLS



Mounted Campana Bell **BCM10** Hand-Held Campana Bell **BCH10**

AGOGO & TRIBELLS



Tri Agogo **PTA30** Pro Cowbell Beater **PDC60** Dual Cowbell Beater **PDC10**

PRIMERO COWBELLS



10" Bell w/ PPS30 **PCB1030** 6" Bell **PCB6** 4" Bell **PCB4** 8" Guiro Cowbell **PCB10GR** 10" Millennium Chrome Bell **PCB10MCR** 10" Anarchy Bell **PCB20**

NOTE: Items pictured are not to scale

DJEMBES

Ancient Instruments for the Modern Percussionist

TOP TUNED DJEMBES

Seamless Synthetic Shell w/ Fiber Style Head

ROPE TUNED DJEMBES

#685
ARTISAN STRAIGHT GRAIN LIMBA

12" x 24"
PBJV12685

12" x 24"
PBJV12686

#686
ARTISAN WEATHERED OAK

14" x 25.75"
PBJV14685

14" x 25.75"
PBJV14686

#684
ARTISAN CYPRESS

12" x 24"
PBJVR12684

12" x 24"
PBJVR12685

#685
ARTISAN STRAIGHT GRAIN LIMBA

14" x 25.75"
PBJVR14684

14" x 25.75"
PBJVR14685

DJEMBES are a traditional African instrument that offer a wide variety of sounds and are perfect for drum circles.

12" Hand Carved Mahogany Djembe #695 Malinke Village **PBJWR12695**

Field Percussion Djembe 14" (Fiberglass) #649 Textured Black **PJF350FP649**

Elite Oak Djembe 12.5" #511 Natural **PJW340**

Elite Fiberglass Djembe #602 Bistre Black **PJF350** 14" **PJF320** 12.5"

Fiberglass Fun Drum **PFD300**

Djembe Stand - Fits 8" to 14" Pearl Rope Tuned and Top Tuned Djembes **PBJSTD**

PBJWR12695



DJEM-BASS

The **PJBS350** Djem-Bass Attachment allows you to convert any Pearl 14" djembe into a sub-sonic bass drum. To reduce the attack and add greater "lows," we have included a cloth cap that stretches around the head. For smoother low-end with a slightly reduced attack, slip the included neoprene disc inside, allowing for two distinct sound options. A pedal (not included) attaches via an I.S.S. clamp to the djembe's stand mounting plate. Includes two legs with mounting hardware, pedal bracket, head cover and neoprene muffler.

Djem-Bass **PJBS350**

FOLKLORIC

FOLKLORIC ELITE CONGAS

Pearl's Folkloric line of congas feature a traditional look with modern innovation that only Pearl can deliver. Each 28" tall Oak drum is designed for the "seated" player, but includes stand mounts for players who prefer to stand. Thicker South American-style natural skin heads make the drums warm-sounding, but a fiberglass gel coating on the interior seals the shell and add the projection and volume desired by today's players. Four Polished Steel Reinforcing Bands are inset on the shell for a smooth touch, and the traditional hoops complete these stunning Cuban instruments.

Folkloric Elite Bongos 7" & 8.5" **PBW300FC**

Tumbador 12.5" **PCW125FC**

Qunito 11" **PCW110FC**

Segundo 11.75" **PCW117FC**

#526 CRIMSON SUNRISE

Uno **PSK50FC**

Segundo **PSK60FC**

Caja **PSK70FC**

10" Segundo Shekere **PBSK70**

Fiberglass Shekere **PSK10**

BATAS

Bata drums originated in Nigeria over 500 years ago and were primarily used for religious purposes. The drums were introduced into Cuba by slaves in the 1820's. Pearl Batas are modeled after an ancient Cuban design and feature naturally finished 100% Thai Oak shells for outstanding and authentic tone. Polished steel traditional rims offer excellent tuning integrity and ease of tuning. These prized ceremonial drums have an hourglass shape and produce a great, warm tone similar to a bongo-like sound on the high drum and a djembe-like tone on the large drum.

Itotele **PBA60**

Oconcolo **PBA50**

Iya **PBA70**

Wood Clave **PCL20FCW**

Bamboo Clave **PCL10FCB**

Shekere Holder **PPS45**

Achere **PAC10FC**

Guataca **PGT10FC**

Cata w/ Holder **PCA14FC**

BRAZILIAN

BRAZILIAN PERCUSSION

Modern refinements and Pearl quality to the traditional Samba musician.

The Timbao is made from lightweight fiberglass, and is capable of the extremely high tension utilized in tradition Brazilian ensembles. The lightweight wood shell Surdos allow for hours of comfortable play when worn over the shoulder with the provided strap. Available in 18"x22", 20"x18" and 22"x22" sizes (diameter x depth), Pearl's popular Surdos continue to be the industry standard.

Our Repinique features lightweight yet sturdy steel shells with etched heads, shoulder straps and low rims for incredible playing comfort.

Timbao **PBTB140**

Tan Tan **PBTA1420**

Surdo 20" **PBS2018**

Surdo 18" (Shown with optional PBS30BD) **PBS1822**

Surdo 22" **PBS2222**

Legs & BD Adapter Kit For Surdo **PBS30BD**

Tamborim Stick **PBT70S**

Surdo Mallet **PBSM20**

Caixa 12"x4" **PBCX1204**

Caixa 12"x6.5" **PBCX1265**

Cuica **PBC80SS**

Repinique 10" w/ Strap **PBR10S**

Repinique 12" w/ Strap **PBR12S**

Pandeiro 10" (5 Sets Platinellas & Goatskin Head) w/ Bag **PBP510**

Pandeiro 12" (6 Sets Platinellas & Plastic Head) w/ Bag **PBP612**

Pandanza w/ Agogo Bell **PDZ510**

Tamborim w/ Quick Draw Mount **PBT60C**

CAJONS



19.25" T x 11.75" W x 11.75" D

Primo Music Genre Cajon
PBC124B

FACEPLATE Meranti*
BODY Medium-Density Fiberboard
SNARES Fixed, two sets
BASS PORT Patented, built in, rear facing
FINISH Crate style body with graphic faceplate

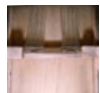

TWO SETS SNARES

Features Pearl's crate design and the faceplate displays the names of some of the most popular musical genres.

18.25" T x 14" W x 14" D

Primo Coffee Bean Cajon
PBC320

FACEPLATE Meranti
BODY Shorea Plywood
SNARES Fixed, three sets
BASS PORT Patented, built in, rear facing
FINISH Crate style body with graphic faceplate

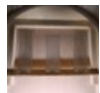

THREE SETS SNARES

The Coffee Bean cajon features Pearl's crate design and the faceplate resembles a crate of Peruvian coffee beans.

19.25" T x 11.75" W x 11.75" D

Primo Acme Cajon
PBC125B

FACEPLATE Meranti*
BODY Shorea Plywood
SNARES Fixed, two sets
BASS PORT Patented, built in, rear facing
FINISH Crate style body with graphic faceplate



BASS PORT

The Acme Explosive cajon features Pearl's crate design and the faceplate resembles a crate of explosives.

19.25" T x 11.75" W x 11.75" D

Willie S. Sparks Electric Cajon
PBEC210

FACEPLATE Meranti*
BODY Shorea Plywood
SNARES Fixed, two sets
BASS PORT Patented, built in, rear facing
FINISH Wood body with graphic faceplate

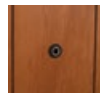

1/4" JACK

Plug in your cajon with a 1/4" jack and amplify the sound of your Willie Seymour Sparks electrified beat generator.

19.25" T x 11.75" W x 11.75" D

Primo Music Town Cajon
PBC122B

FACEPLATE Meranti*
BODY Medium-Density Fiberboard
SNARES Fixed, two sets
BASS PORT Patented, built in, rear facing
FINISH Crate style body with graphic faceplate

The Music Town USA cajon is designed to resemble a wooden crate and the faceplate features the names of some of America's iconic music cities.

19.25" T x 11.75" W x 11.75" D

Primo Tree of Life Cajon
PBC123BTR

FACEPLATE Meranti*
BODY Medium-Density Fiberboard
SNARES Fixed, two sets
BASS PORT Patented, built in, rear facing
FINISH Hand painted and silkscreen Tree of Life

The Tree of Life cajon features a hand painted and silkscreen design that wraps around three sides and depicts the Tree of Life.

19.25" T x 11.75" W x 11.75" D

Primo Raven Cajon
PBC123BBR

FACEPLATE Meranti*
BODY Medium-Density Fiberboard
SNARES Fixed, two sets
BASS PORT Patented, built in, rear facing
FINISH Hand painted and silkscreen black raven

The Raven cajon's finish is a hand painted and silkscreen design that wraps around three sides and features a stylized black raven.

19.25" T x 11.75" W x 11.75" D

Primo Abstract Red Cajon
PBC120B

FACEPLATE Meranti*
BODY Medium-Density Fiberboard
SNARES Fixed, two sets
BASS PORT Patented, built in, rear facing
FINISH Abstract Red body with black faceplate

Its unique finish is an abstract red print on a cloth sarong that is applied to the body of the cajon and is accentuated by the ebony front.

*FACEPLATE REPLACEMENT MODEL: **FP123B**

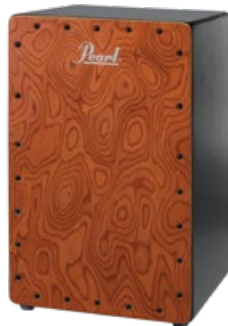

19.25" T x 11.75" W x 11.75" D

Primo Figured Cherry Cajon
PBC121B

FACEPLATE Figured Cherry*
BODY Medium-Density Fiberboard
SNARES Fixed, two sets
BASS PORT Patented, built in, rear facing
FINISH Natural Figured Cherry w/ gloss black body

Features a stunning figured Cherry faceplate. Because of its hardness, tonally cherry is a close match to maple and when used on a cajon provides more bottom-end.



18.75" T x 12.5" W x 12.5" D

Jingle Cajon
PCJ629616

FACEPLATE Asiatic hardwood
BODY Fiberglass
SNARES Fixed, three sets
BASS PORT Rear facing
FINISH #616 Artisan Wood Grain

Simply twist open the Brazilian Platinnella-style jingles and a new world of sonic options open up, as you sound like two percussionists blending simultaneously.



18.75" T x 12.5" W x 12.5" D

Boom Box Cajon
PCJ633BB635

FACEPLATE Asiatic hardwood
BODY Fiberglass
SNARES Fixed, three sets
BASS PORT Built in, rear facing
FINISH #635 Artisan Zebra Wood

The Boom Box Cajon creates never-before-heard low-end frequencies from a Fiberglass cajon! Features a fixed snare system and a built-in bass port for subsonic frequencies you have to hear to believe!



18" T x 14" W x 14" D

Primo Bass Boom Cajon
PCJ1418BBM2

FACEPLATE Meranti
BODY Medium Density
SNARES Fixed, three sets
BASS PORT Built in, rear facing
FINISH Crimson body with black faceplate

Traditional style, classic look, amazing sound. The Bass Boom cajon will get the job done in style.

*FACEPLATE REPLACEMENT MODEL: **FP123B**

CAJON ACCESSORIES



Cajon Holster Nylon
w/ Velcro Straps
CAJH100



Seat Cushion w/ Thick Foam.
Adds comfort for long sessions.
PSCBC



Box Cajon Case
13" x 14" x 20"
PSC1213CJ



Cajon Stand
PCJ70STD

HANDPANS

A Cosmic Blend of Sound

MELODIC HANDPAN



Handpans are musical instruments that are a subset of the steelpan. The beautiful tonal characteristics will remind you of steel drums, but handpans are only played by hand, with no sticks or mallets, so the sound has reduced attack but is much more mellow.

The shape of Pearl's 22" Awakening Series Melodic and Euphonic handpans feature a center tone field surrounded by eight tone fields. Each tone field has a fundamental note, an octave, and an overtone, so each field has three notes. The hand-crafted steel construction of the instrument is designed so each tone field holds its tuning.

The Melodic handpan features a patina finish and is meticulously tuned to the D Minor scale, and responds to your finger strikes with excellent sonority.

22" Melodic Handpan
9 Note D Minor - Patina Finish
PBHP500

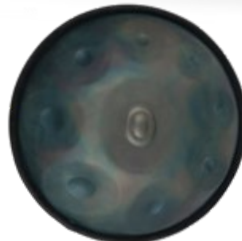
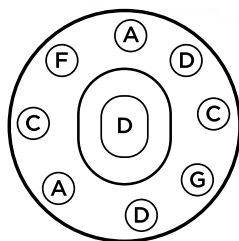

Hand Hammered Tone Field



Rubber Edge Protection



Padded Case Included

EUPHONIC HANDPAN

The gray Euphonic handpan is designed for budget-conscious players and tuned to F Minor. Both models include a sturdy, PVC reinforced backpack-style bag to protect the handpan during travel and storage. Tabletop and floor stands are also available but sold separately.

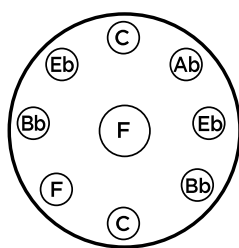

Case Included



22" Euphonic Handpan
9 Note F Minor - Gray Lacquer Finish
PBHP300G

HANDPAN ACCESSORIES



8" x 1.75" Donut
Foam Wrapped PVC

Handpan Table Top Stand
PTTD10



Adjusts from 36"-40" tall

Handpan Floor Stand
PBFS30



NOTE: Items pictured are not to scale

Fits any 20"-22" handpan

Handpan Case
PBHPB50

TONGUE DRUMS

Cosmic Blend of Tones



AWAKENING SERIES TONGUE DRUMS

Pearl proudly introduces the Awakening Series of 6 Tongue Drums: Three 8 note and three 9 note drums tuned to pentatonic scales.

Tongue drums derive their name from the tongue shaped areas where you strike the drum. The results are a cosmic blend of tones that are as much fun to hear as play.



8 Note G Major #687 Blue Burst
PMTD8GMF687



8 Note A Ake Bono #688 Brown Burst
PMTD8AKBF688



8 Note A Minor #689 Green Burst
PMTD8AMF689



9 Note C Lydian #690 Orange Burst
PMTD9LYDF690



9 Note C Major #691 Crimson Burst
PMTD9CPTF691



9 Note C Ake Bono #692 Purple Burst
PMTD9AKBF692



9 Note C Ake Bono #692 Purple Burst
PMTD9AKBF692



Rubber mallets included

Each drum features a 10" hardened steel shell with precise laser cut tongues for accurate and consistent tuning. Pearl Tongue drums can be played with your fingers or with a set of mallets included with each drum.



Tongue Drum Bag
PTDB10B

AWAKENING SERIES



Rainsticks and Nut Shakers

RAINSTICKS

BAMBOO RAINSTICKS WITH BURNED FINISH #694 RHYTHM WATER

- 60" Bamboo Rainstick **PBRB60694**
 - 48" Bamboo Rainstick **PBRB48694**
 - 40" Bamboo Rainstick **PBRB40694**
 - 32" Bamboo Rainstick **PBRB32694**
 - 24" Bamboo Rainstick **PBRB24694**
 - 16" Bamboo Rainstick **PBRB16694**
- Pearl's natural Bamboo Rainsticks are 2.5" in diameter and feature an internal spiral maze of tines that a cascade of lava pebbles flow over to create the soothing sound of falling rain.
- 16" Bamboo Rainstick **PBRSP16693**
 - 24" Bamboo Rainstick **PBRSP24693**
 - 32" Bamboo Rainstick **PBRSP32693**
 - 40" Bamboo Rainstick **PBRSP40693**
 - 48" Bamboo Rainstick **PBRSP48693**
 - 60" Bamboo Rainstick **PBRSP60693**

Pearl has expanded its line of shakers to include six Bamboo rainsticks ranging in size from 16" to 60" and available in two unique finishes.

BAMBOO RAINSTICKS WITH PAINTED FINISH #693 HIDDEN SPIRIT

NUT SHAKERS

The Awakening Series has been expanded to include a series of natural nut shakers that provide earthy tones that complement the series. Kenari, Bendo, and Pangi nuts range in size from small,

medium, and large and each size possesses unique sound properties. From the recording studio to the yoga studio Pearl's Awakening Series has an instrument and sound that will inspire you.



Pangi Nut Shaker w/ Rope Handle **PBPGRH14**



20 INDIVIDUALLY STRUNG PANGI NUTS
Deeper, earthy tone.



Pangi Nut Shaker w/ Bamboo Handle **PBPGBH12**

BAMBOO HANDLE
Gives player more control.



Bendo Nut Shaker w/ Rope Handle **PBBSKRH**



16 STRANDS OF BENDO NUTS
Bright, woody tone.



Kenari Nut Bracelet Shaker **PBGLKEN**



14 HAND STRUNG KENARI NUTS
Worn to layer sounds.



26 Kenari Nut Wind Chime *Clamp not included **PBKENCH01**



MAHOGANY CROSS BAR
Suspended nuts for unique earthy sounds.



Kenari Nut Shaker 7" **PBSHKENL**



22 STRANDS OF KENARI NUTS
Full, robust tone.

CONCERT PERCUSSION

Engineered for the Professional Percussionist



Pearl is proud to offer Concert Percussion instruments that are attractively priced for school ensembles, yet engineered with the professional percussionist in mind. The symphonic tambourine is a perfect example. Its 17 pairs of specially aged, stamped brass jingles provide a dry, yet bright tone that brings added color to any musical situation. Its 10" headed wood frame allows the player to effortlessly

perform all tambourine techniques, and the tambourine's plush carrying case is included. The rattler is another vital component to any concert percussionists' equipment, and Pearl's is built with an extended handle for a comfortable grip and ease of playing. Holders for the rattler and castanets are also available.



Mix Copper And Brass **PETM1018CR**

Mix Copper and Bronze **PETM1018CB**

Mix German Silver and Copper **PETM1018GC**

Beryllium Copper **PETM1018CP**

German Silver **PETM1018GS**

ORCHESTRAL TAMBOURINES

The Pearl Orchestral Series Professional Tambourines provide performers a new voice and sound for any performing situation.

These 5 instruments feature uniquely sourced and hand-hammered jingles combinations of German Silver, Phosphor Bronze, Beryllium Copper, and Yellow Brass that give a full spectrum of color and projection options to players. The 10" shell is a well-

balanced and lightweight 2-ply Mahogany design with contoured hand-hold areas for comfortable performance and warm tone. The natural finish goatskin head provides a full responsive sound and traditional look without sacrificing durability.



16" Ocean Drum **PSFM16**

14" Frame Drum **PFR14C**

Frame Drums Set of 6 - Sizes: 8", 10", 12", 14", 16", 18" **PFR0818C**



Castanets (Long Handle) **PCN20**

Castanets **PCN20S**

Castanets Holder **PCN20H**

Slap Stick **PSS100**

Elite Concert Wood Blocks (High) (Medium) (Low) **PCWB100A PCWB200A PCWB300A** Mounting Bracket incl.



Stix-Free Triangle Holder w/ 8" Triangle **PSP12T**

Triangle 10" **PET100** 8" **PET80** 6" **PET60**

Triangle Beater **PETB30**

Triangle Clip **PTC10**

Temple Blocks **PCWTB05**

Rattler **PRT10**

HAND PERCUSSION

A World of Hand Percussion

BLOCKS, BELLS, SHAKERS and more. Choose from a complete selection of hand percussion instruments to add color and impact to your music.

GUIROS



Natural Gourd Guiro
PNG20

Two scraping surfaces: thin grooves on one side for a lighter sound and thicker cut channels on the other side for a beefier sound. The interior is coated with fiberglass gel coat to add projection and volume.



Metal Guiro
PMG20

Perfect for Merengue rhythms, or just a different metallic sound texture, Pearl's Metal Guiro will become an essential ingredient in your "toy" bag. Scraper included.



Fiberglass Guiro
PFG20

Pearl's Fiber Guiro is light-weight and provides optimal projection due to its fiberglass construction. With the included striker and two different playing surfaces you have a world of sonic possibilities in your hand.



Guiro Holder
PGH20

This innovative design will hold virtually any size guiro secure for one handed playing. Easily mountable off the lug of your conga or any 3/8" post, Pearl's Guiro Holder uses a track system to lock the guiro in place. Included is a 3/8" "Z" rod so you can also mount your favorite accessory as well.



Beaded Maracas
PFM20

The Beaded Maracas feature Shekere-style beads which offer an excellent sound with greater control, and foam handles for enhanced comfort.



Maracabasa
PFM50

The Maracabasa is two great instruments in one, combining the functionality of a maraca and a cabasa in one handheld instrument. Featuring a ribbed fiberglass body wrapped in shekere-style beads.



Basket Ganza 9" X 4"
PGA20

The Pearl basket ganza is a 9"x4" woven tube containing wooden sticks instead of conventional shot. The wood sticks produce an airy percussion sound.



Shakelets
PWR40

This innovative percussion item feature exclusive "Ganzinellas", Brazilian-style plantinellas combined with ganza shakers that are worn on the wrists to produce a shaker sound when playing.



Spirit Chimes w/ Holder and Mallet
PSC30BR

Spirit Chimes have many applications in school bands, percussion ensembles and music programs. They are also perfect for meditation and yoga studios.



36 Anodized Aluminum Chimes w/ Case, Holder, And Striker
PWCH3620A

- Satin black frame with polished bars
- Self-dampening parallel swinging chimes



32 Gold Anodized Aluminum Chimes w/ Case, Holder, and Striker
PWCH3220G

- 32 Gold anodized aluminum chimes
- Self-dampening parallel swinging chimes



32 Bar Aluminum Windchimes w/ Case, Holder, and Striker
PWCH3220A

- 32 Anodized Aluminum Chimes
- Self-dampening parallel swinging chimes



Foldable 36 Anodized Aluminum Chimes
PWCHF3620AF

- Individually strung, goes from 19.25" to 9.75"
- Self-dampening parallel swinging chimes



Quickmount Tambourine w/ Steel Jingles
PTM10SHX

Six double rows of premium steel jingles deliver a bright metallic sound. Features a comfort grip handle that slides into the shock-absorbing Quickmount bracket. Mounts to any 3/8" post.



QUICKMOUNT BRACKET
Hand-held to mounted in seconds.



Quickmount Tambourine w/ Brass Jingles
PTM10GHX

Six double rows of premium brass jingles deliver with bright and a warm metallic sound. Comfort grip handle that slides into the shock-absorbing Quickmount bracket. Mounts to any 3/8" post.



COMFORT GRIP HANDLE
Molded ergonomic shape.



Ultra Grip Volume Adjustable Tambourine
PTM50BHR (Brass)

The jingle control discs can be moved to the outside to allow the jingles to ring freely. As the jingle control discs are tighten the more restricted the jingle.



PTM50SHR (Stainless Steel)

Brass is an alloy of copper and zinc and the jingles provide a bright mid-range tone. Steel jingles have a higher tone with extra top end and sustain.



9" Primero Rock Tambourine w/ Millennium Chrome Jingles
PTM09BK

The Primero Rock Tambourine features 6 double sets of Millennium Chrome Jingles in a matte black oval frame.



Headless Wood Tambourine
PTH10B (Brass)
PTH10S (Stainless Steel)

Brass is an alloy of copper and zinc and the jingles provide a bright mid-range tone.



Hi-Hat Jingle Ring
PJH10SH

The Hi-Hat Jingle Ring has 20 sets of Stainless Steel tambourine style jingles that will accentuate your Hi-Hat sound with every opening and closing of your cymbals.



Gatling Cabasa
CBS100

Simply grab the precision handle and fire away to play any pattern you wish, or keep spinning it for an infinite "sizzle" that is not possible with standard Cabasas.

ASH TONE BLOCKS



Tang-Tang
PTG20

A high and low pair of unique shakers that incorporate a Caxixi-Style Plate and Wooden "Clacker."



(High) **PAB20** (Medium) **PAB50** (Low) **PAB100**

Pearl's Ash Tone Blocks are constructed using Ashwood because it is extremely hard and durable. The Ash Tone Blocks are pitched in "thirds" and each block includes a mounting bracket that accepts a 3/8" post.

CLAVE BLOCKS



(High) **PBL10** (Medium) **PBL20** (Low) **PBL30**

Pearl's clave blocks are injection molded so they're virtually indestructible, and the solid color will never chip, fade, or peel. Our exclusive CDV (Chamber Density Variation) Technology process allows all three clave blocks to be the same dimensions but still differ in pitch.



Anarchy Block
PBL100

Produces a low piercing pitch that will cut through even the heaviest metal rhythm section.



21" Field Percussion Shaker
PGA60FP

Hexagonal body and internal chamber for a truly massive sound.



Wood Hex Ganzas
PGA30W (Short) PGA32W (Long)

The wood Hex Ganzas are made from Shorea wood and maintain the same strong projection as their aluminum brothers, but deliver a warmer less metallic tone.



Hex Ganzas
PGA30 (Short) PGA32 (Long)

The Pearl aluminum Hex Ganzas give more sound control than round shakers and produce a lush shake sound due to their hexagonal shape.



Triple Shaker
PGA40

6" long, rectangular aluminum shaker provides three unique sounds: shake, click, and swish.



Groove Shaker
PGA50SF

Can be played as a traditional shaker or while holding a drumstick.



Egg Carton
PEC1

Three egg shakers in a clear tube that can be played separately or as a complete unit.

STANDS

Pro Tools for Every Gig

CONGA STANDS

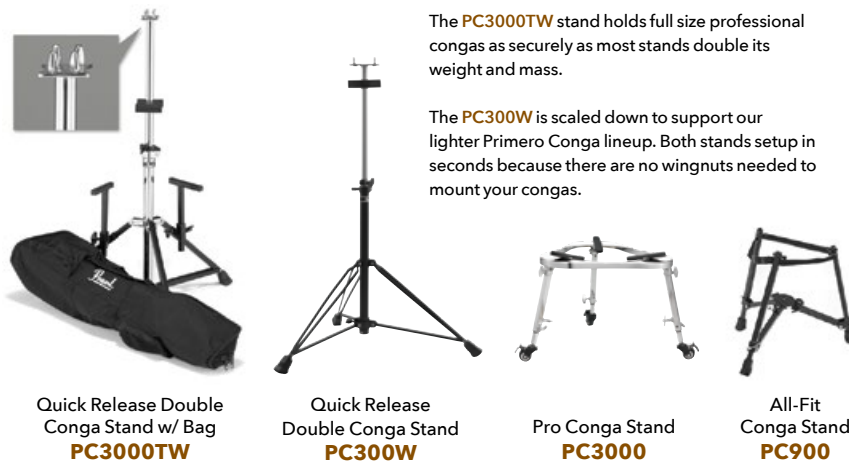

Quick Release Double Conga Stand w/ Bag
PC3000TW

Quick Release Double Conga Stand
PC300W

Pro Conga Stand
PC3000

All-Fit Conga Stand
PC900

The **PC3000TW** stand holds full size professional congas as securely as most stands double its weight and mass.

The **PC300W** is scaled down to support our lighter Primero Conga lineup. Both stands setup in seconds because there are no wingnuts needed to mount your congas.

The **PC2500** Ultralite Conga stand, is lightweight yet sturdy and stable. Index markings on all adjustable parts make for consistent lightning fast setups.



Primero Twin Conga Stand
PC200

Ultra Lite Conga Stand
PC2500

Primero Basket Conga Stands
PC100P (10") PC110P (11")

BONGO STANDS



Pro All Fit Bongo Stand with Spring Loaded Strap Hinge
PB3000

Bongo Stand for Seated and Concert Players
PB3000S

All-Fit Tilting Bongo Stand
PB900LW

Lightweight Bongo Stand
PB700

Bongo Attachment for PC200
PB700BHS

DJEMBE STANDS

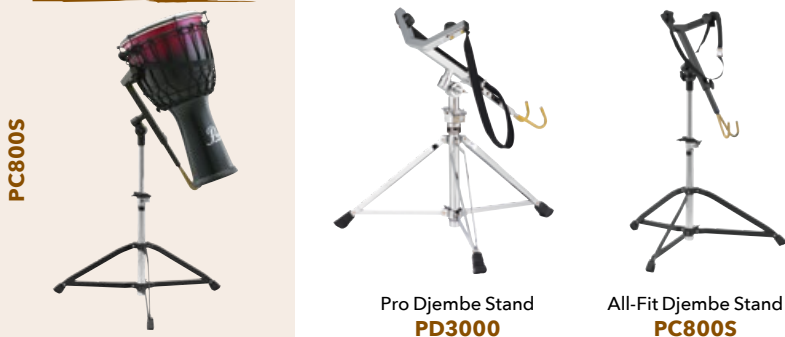

Pro Djembe Stand
PD3000

All-Fit Djembe Stand
PC800S

HEIGHT: 16" to 21"

CAJON STANDS

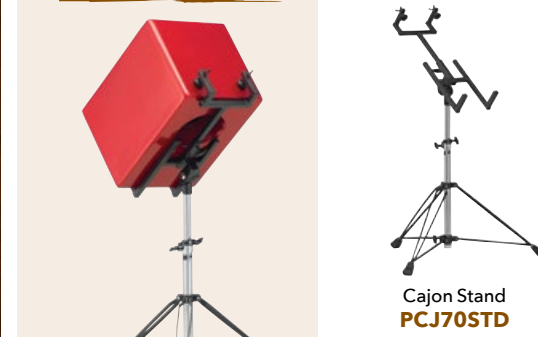

Cajon Stand
PCJ70STD

TRAP TABLES

Pearl's wide selection of trap tables and accessories feature sturdy and dependable options for any musical situation. Options include a variety of sizes, construction materials, tables with stands, tray tops and table tops only and single or double braced legs.

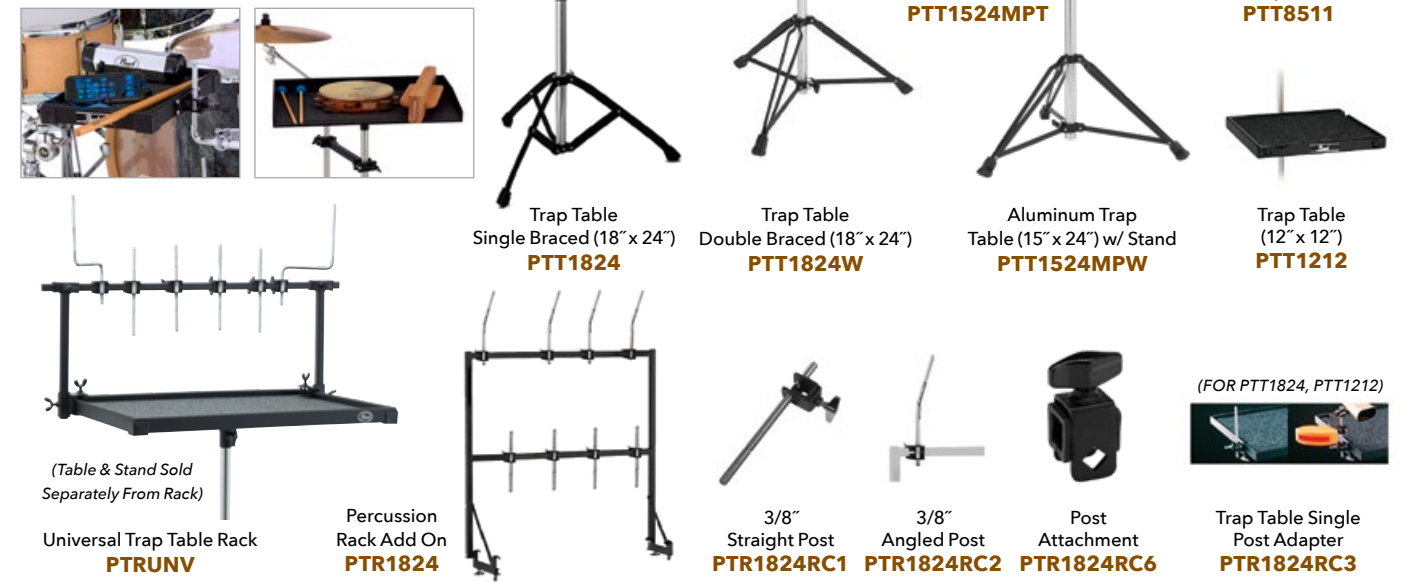

(Table & Stand Sold Separately From Rack)

Universal Trap Table Rack
PTRUNV

Percussion Rack Add On
PTR1824

Trap Table Single Braced (18" x 24")
PTT1824

Trap Table Double Braced (18" x 24")
PTT1824W

Aluminum Trap Table (15" x 24") w/ Stand
PTT1524MPW

Trap Table (12" x 12")
PTT1212

(FOR PTT1824, PTT1212)



Trap Table Single Post Adapter
PTR1824RC3

PERCUSSION CASES

Features include: ergonomic carrying straps, rubber protective bottoms, top-mounted carrying handles, tuning wrench pouches, & heavy duty double zippers.



Fits Havana Series

11" & 11.75" Conga Bag
PSC117CGW

12.5" Conga Bag
PSC125CGW

12" Djembe Bag
PBJCXL

14" Djembe Bag
PBJCXXL

Bongo Bag
PSCBB

12.5" Conga Bag
PSC125CG

11" Conga Bag
PSC110CG

Box Cajon Case 13" x 14" x 20"
PSC1213CJ



Travel Conga Case
PSC140DJ

PSC125CG Fits 11.75" & 12" Congas

PSC140DJ Fits 12.5" & 14" Congas

HOLDER & ACCESSORIES



Angled Post Adapter
PPS37

Lug Mount Accessory Holder
PPS40

Universal Guiro Holder
PGH20

Foot Pedal Bracket
PPS20

Cowbell Stacker
PCS10

Stix-Free
PPS10 & PPS11

Percussion Toy Box (Accessories Not Included)
PTYB1212

COWBELL HOLDERS



CA130

75H

75X

PPS81

PPS82

REPLACEMENT PARTS

MASKING COVERS & MOUNTING BRACKET

The GK90 and BBC1 cover the holes of BT3 and BB3 brackets that have been removed.



- BBC1** For BB3, w/Gasket, Screws and Nuts
- GK90** For BT3, inside/outside plates w/ Bolts
- BT3** Tom Tom Bracket

BASS DRUM HOOP PROTECTORS



- HPP2** Metal Hoop Protector for Wood BD Hoops
- NP01** Hoop Protector for Metal BD Hoops
- NP347/2** Non-Slip Hoop Protector for Wood BD Hoops (pair)

P2050 SERIES CAMS



- ELIMINATOR OPTION CAM**
- CAMPL** Purple Cam, Aggressive Action
 - CAMYL** Yellow Cam, Inverse Action
 - CAMTBK** Translucent Black Cam, Linear Action
 - CAMTWT** Translucent White Cam, Oversized Linear Action
 - CAMTBL** Translucent Blue Cam, Progressive Action
 - CAMTRD** Translucent Red Cam, Radical Action

FLOOR TOM LEGS & BRACKETS

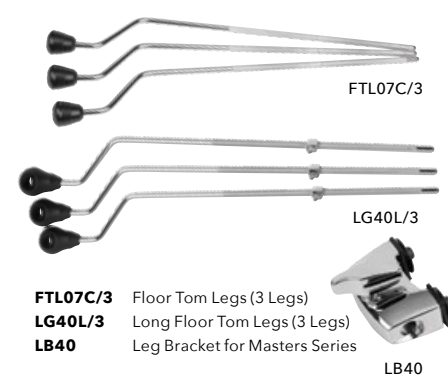

- FTL07C/3** Floor Tom Legs (3 Legs)
- LG40L/3** Long Floor Tom Legs (3 Legs)
- LB40** Leg Bracket for Masters Series

HI-HAT CLUTCHES & PARTS

RAPID LOCK HI-HAT CLUTCHES

Hi-Hat set-up and tear-down is a breeze with Rapid-Lock's Patented* two-point quick release locking system. *U.S. Patent #9355625



- HCL205DQR** Rapid Lock Quick Release Hi-Hat Drop Clutch w/ Locking Nut
- HCL205QR** Rapid Lock Quick Release Super Grip Hi-Hat Clutch w/ Locking Nut
- HCL105QR** Rapid Lock Quick Release Hi-Hat Clutch w/ Locking Nut
- HCL79** Hi-Hat Clutch Complete
- HHC90** Plastic Cup w/ Tilter

CHAINS & BELTS



- CCA5** Chain Assy Complete for Eliminator Pedals
- BCA250** Belt Assy Complete for P2050 Eliminator Pedals

SPRING



- SP64F** Spring for P930/P932

BEATERS & BEATER WEIGHTS



- DB100** Duo-Beater Felt/Plastic
- B250QB** Control Core Quad Beater

- BEATER WEIGHTS**
- BW100** Beater Weight, 3 Weights in One (U.S. Patent #7122730)

MASTERCAST HOOPS

MasterCast are the finest die cast hoops available and feature the perfect blend of thickness and mass to improve the depth, clarity, and focus of toms and snare drums.



SUPERHOOP II & FATTONE HOOPS

SuperHoop II hoops are precision formed from heavy-duty 2.3mm steel, triple-flanged and engraved with the SuperHoop II logo. FatTone hoops are low mass 1.6mm hoops with hemmed and welded edges for strength and rigidity.



STEEL HOOPS

Steel Hoop Model #	Diameter	# of Tension
RH0804	8"	4
RH1006	10"	6
RH1206	12"	6
RH1306	13"	6
RH1408	14"	8
RH1408S	14"	8 Snare side
RH1608	16"	8
RH1808	18"	8

BASS DRUM PEDAL TRAINING PAD

The BD10 bass pad is perfect for practicing at home or on the road. The wide pad accommodates double pedals and is specially formulated for extremely low noise and a realistic feel. The universal-fit "hoop" accepts all brands of pedals and adjusts to compensate for different floor surfaces. The BD10 folds for compact transport.



- BD10** Bass Drum Pedal Training Pad

QUICK RELEASE WINGLOC



- WL230** Quick Release WingLoc
- WL230A** Quick Release WingLoc Complete

SEAT CUPS AND FELTS



- RC20** Reversible Seat Cup, w/ O-Ring
- PL11** Cymbal Seat Cup
- FLW001/2** Cymbal Felt Washer (2 Pieces)
- FLW003** Hi-Hat Cup Felt Washer

STOP LOCK



- ZD081A** Stop Lock Complete

DRUM KEYS



- KGT100H** Gyro Tune Key w/ Quick Release
- K030** Hi-Tension Tuning Key
- K080** Tuning Key
- K180** Spin-Tight Key

AIR SUSPENSION FEET



- R40/3** Air Suspension Rubber Feet (3 Each)
- R5/3** Rubber Tip

Model #	Diameter	# of Tension
DC0805	8"	5
DC1006	10"	6
DC1206	12"	6
DC1306	13"	6
DC1408	14"	8
DC1408S	14"	8 Snare Side
DC1410	14"	10
DC1410S	14"	10 Snare Side
DC1410SG	14"	10 Snare Side w/ Guard
DC1508	15"	8
DC1608	16"	8
DC1808	18"	8

Super Hoop Model #	FatTone Hoop Model #	Diameter	# of Tension
SH0604	NA	6"	4
SH0805	FH0805	8"	5
SH1006	FH1006	10"	6
SH1006S	NA	10"	6 Snare Side
SH1206	FH1206	12"	6
SH1208	NA	12"	8
SH1208S	NA	12"	8 Snare Side
SH1306	FH1306	13"	6
SH1308	FH1308	13"	8
SH1308S	FH1308S	13"	8 Snare Side
SH1408	FH1408	14"	8
SH1408S	NA	14"	8 Snare Side
SH1410B	FH1410	14"	10
SH1410S	FH1410S	14"	10 Snare Side
SH1410SG	NA	14"	10 Snare Side w/Guard
SH1508	FH1508	15"	8
SH1510S	NA	15"	10 Snare Side
SH1510B	NA	15"	10
SH1608	FH1608	16"	8
SH1808	FH1808	18"	8

LUGS

- CL05** Lug for 3" Piccolo Snare
- CL50** Lug for 5" Deep Snare
- CL55** Lug for 5.5" Deep Snare
- CL65** Lug for 6.5" Deep Snare
- CL100** Lug for 7" Deep Snare



MASTERS MAPLE GUM SHOWN WITH MASTERCAST HOOPS



MASTERS MAPLE COMPLETE SHOWN WITH SuperHoop II HOOPS

REPLACEMENT PARTS

OPTI-LOC



OPL1016/C

Opti-Loc suspension tom holders provide exceptional stability while greatly improving resonance and sustain. (For EXX / EXL Export / DMP)

- OPL0608/C** Opti-Loc for EXX and DMP 6"-8" Diameter
- OPL1016/C** Opti-Loc for EXX and DMP 10"-16" Diameter

JUNGLE GIG



JG16

JG16 • Pearl's Jungle Gig allows the conversion of a 16" Floor Tom to a Bass drum.

MUFFLERS

External clamp-on muffler for snare drums and toms. By adjusting the pressure and position of the felt pad, excessive overtones can be precisely controlled or eliminated.



OM1

OM1 Clamp-on Muffer, Snare Drum & Toms

MUFFLE HEADS

Model #	Size	Model #	Size
MFH08	8"	MFH14	14"
MFH10	10"	MFH16	16"
MFH12	12"	MFH20B	20"
MFH13	13"	MFH22B	22"

BASS DRUM MUFFLER



BDMF

BDMM

BDMF Bass Drum Muffer (Full Size)
BDMM Bass Drum Muffer (Mini Size)

TENSION ROD LOCKNUTS



TNK10N/10

TL20/10

TNK10N/10 Tension Keeper (10/pkg)
TL20/10 Tension Rod Lock Nuts (10/pkg)

TENSION ROD WASHERS



NLW12B/12

MTW12/12

NLW12B/12 Nylon Washers (12) Black
MTW12/12 Metal Washers (12)

Pearl offers a tremendous number of parts for our drums and hardware. The parts represented on these pages are some of the most commonly requested items.

STRAINERS



SR017

SR014N Standard Snare Strainer
SR017 Snare Strainer Complete
SR018 Snare Strainer Complete



ON

OFF

THE SR017 STRAINER Simple and effective, the SR017 is a Pearl standard for effortless snare switching and sensitivity control. Its smooth lever action and fine-tuning knob let you dial in the right amount of snare wire saturation to suit your personal sound.

ULTRA-SOUND SNARES

Pearl's Ultra-Sound snares feature patented Graduated Tension wires for extended dynamic range from ultra soft to ultra loud. Ultra-thin, low mass end plates assure ultra quick response. The end plates feature three mounting options: tunnels or holes for cord mounting and slots for straps. U.S. Patent #7202405

20 / I 20 / D 20 / C



SN1320C 20 strands for 13", C-type, w/ straps & cords
SN1320D 20 strands for 13", D-type, w/ straps & cords
SN1320I 20 strands for 13", I-type, w/ straps & cords
SN1420C 20 strands for 14", C-type, w/ straps & cords
SN1420D 20 strands for 14", D-type, w/ straps & cords
SN1420I 20 strands for 14", I-type, w/ straps & cords



SN1442C 42 strands for 14", C-type, w/ straps & cords
SN1442D 42 strands for 14", D-type, w/ straps & cords
SN1442I 42 strands for 14", I-type, w/ straps & cords

REPLACEMENT SNARES



SPS18/6
SNC500R/4

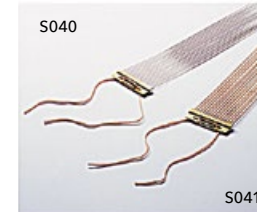

S040

S041

S022N 20 Strand for 14" w/ Cords
S022NU 20 Strand for 14" w/ Cords, Uncoated
S022 20 Strand for 14" w/ Straps
S025 20 Strand for 14" long, w/ Straps
S029N 20 Strand for 13" w/ Cords
S030N 24 Strand for 14" w/ Cords
S031N 20 Strand for 12" w/ Cords
S032N 16 Strand for 10" w/ Cords
S033N 16 Strand for 12" w/ Cords
S040 15 Strand for 14" w/ Cords, Steel Cable, Thinner Gauge
S041 15 Strand for 14" w/ Cords, Bronze Cable, Thicker Gauge
SPS18/6 Plastic Strap (6/pkg)
SNC500R/4 Snare Cord (4/pkg)

SPIN-TIGHT™ TENSION RODS

Specially-designed stainless steel tension rods that lock to maintain tension settings. Starter pack includes 4 Spin-Tight Tension rods with K180 Drum Key.



K180

SPT5047 W7/32 x 47mm (1)
SPT45PK W7/32 x 47mm (4) w/ K180 Drum Key
SPT6PK W7/32 x 47mm (6)

STAINLESS STEEL TENSION RODS

Pearl's Stainless Steel Tension Rods are machined, not forged, from a single piece of stainless steel to the most exacting tolerances in the industry. They feature super-smooth, precise tensioning, with absolutely no play. Each non-plated stainless steel tension rod is matched with a precision-machined brass swivel nut for ultra-precise performance.



SST5028/6 W7/32 x 28mm (6)
SST5035/6 W7/32 x 35mm (6)
SST5038/6 W7/32 x 38mm (6)
SST5042/6 W7/32 x 42mm (6)
SST5047/6 W7/32 x 47mm (6)
SST5052/6 W7/32 x 52mm (6)

TENSION RODS

T055/6 W7/32 x 28mm (6) for 3" Deep Snare
T060/6 W7/32 x 35mm (6) for Free Floaters before 2002
T061/6 W7/32 x 42mm (6)
T061L/6 W7/32 x 47mm (6) for 6.5" Deep Snare
T062/6 W7/32 x 52mm (6) for 5.5" Deep Snare
T065 M6 x 90mm (Bass Drum)
T066 M6 x 115mm (Bass Drum)
TR5052 W7/32 x 52mm (DMP, EXL, EXX, MDT Snare)
TR5047 W7/32 x 47mm (DMP, EXL, EXX, MDT Toms)
TR5100 W7/32 x 100mm (Bass Drum)



T055/6

T060/6

T061/6

T061L/6

T062/6

T065

T066



AARON SMITH
Independent



ADAM TUMINARO
OrlandoDrummer



ADRIAN BENT
Drake/Daniel Caesar



AREJAY HALE
Halestorm



ALVIN FORD
Trombone Shorty



EDDIE BAYERS
Nashville Legend



ELISE TROUW
Independent



ERIC SINGER
KISS



FLO MOUNIER
Cryptopsy



FREDO ORTIZ
Los Lobos



AUSTIN BURCHAM
ABDRUMS



BAARD KOLSTAD
Leprous



BARRY KERCH
Shinedown



BEN GORDON
Parkway Drive



BEN JOHNSTON
Biffy Clyro



GARY HUSBAND
Independent



GENE HOGLAN
Testament/Dethklok



GABE HELGUERA
I Prevail



GEORGE KOLLIAS
Nile



GREG HUTCHINSON
Independent



BILLY HART
Jazz Legend



BRANDON PERTZBORN
Suicidal Tendencies



BRANDON COMBS
Leon Bridges



BRIAN FRASIER-MOORE
Justin Timberlake / Pink



BRUNO ESRUBILSKY
Mitski



GREYSON NEKRUTMAN
Independent



HARRY MIREE
Hardy



HORACIO HERNÁNDEZ
Latin Legend



IAN PAICE
Deep Purple



INFERNO
Behemoth



BRUNO VALVERDE
Angra



CALVIN RODGERS
Independent

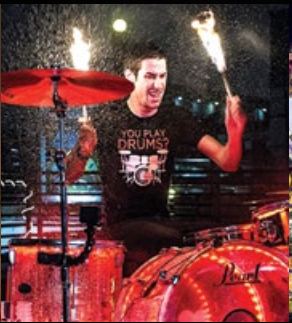

CASEY COOPER
@COOP3RDRUMM3R



CHAD SEXTON
311



CHARLIE ENGEN
Five Finger Death Punch



ISAC JAMBA
Independent



JASON BITTNER
Overkill / Shadows Fall



JASON BOWLD
Bullet For My Valentine



JASON HARTLESS
Ted Nugent / Studio



JEFF MARINO
Darius Rucker



DAN PRESLAND
Ne Obliviscaris



DANIEL ERLANDSSON
Arch Enemy



DARION JA'VON
Doja Cat



DENNIS CHAMBERS
Drumming Legend



DESMOND DAVIS
Mickey Guyton



JEN LEDGER
Skillet / Ledger



JERROD SULLIVAN
The 4 Korners



JESSIE CARABALLO
Marc Anthony



JOCKE WALLGREN
Amon Amarth



JOE TOMINO
Matisyahu / Dub Trio



JOE JORDISON In Memoriam
JOE KRAMER Aerosmith
JOHN LONGSTRETH Origin
JON LARSEN Volbeat
JONATHAN MOVER Independent



MIKE MILEY Rival Sons
MIKE WENGTEN Disturbed
MORGAN ROSE Sevendust
NATE MORTON The Voice
OMAR HAKIM Independent



JUAN "CARLITO" MENDOZA Independent
KAI HAHTO Nightwish
KEIO STROUD Independent
KENT SLUCHER Luke Bryan
KENWOOD DENNARD Independent



PETAR JANJIC Cory Wong
PETE WEBBER Havok
QUINTON "Q" ROBINSON Independent
RAY LUZIER Korn / KXM
RICKY LEWIS The Weeknd



KIKO FREITAS Independent
KRIS BOWERING Orville Peck
KRIS MYERS Umphrey's McGee
LENNY "THE OX" REECE The Lesson GK
LESTER ESTELLE Kelly Clarkson/Sessions



ROBBY AMEEN Independent
SAM LOEFFLER Chevelle
SERGIO MELO The Voice Brazil
SHANE GAALAAS Cosmosquad
SHANNON FORREST Sessions



LOUIE PALMER Independent
MARCUS FINNIE Independent
MARVIN "SMITTY" SMITH Independent
MATT ABTS Gov't Mule
MATT HALPERN Periphery



TARON LOCKETT Cory Henry And The Funk Apostles
TAVARIUS JOHNSON Jon McReynolds / Lalah Hathaway
TERENCE HIGGINS Tab Benoit / Ani DiFranco
TODD SUCHERMAN Styx
TONY PALERMO Papa Roach



MATT MCGUIRE The Chainsmokers
MICHEL'LE BAPTISTE Lizzo
MICHAEL CARTELLONE Lynyrd Skynyrd
MIGUEL LAMAS Independent
MIKE MANGINI Dream Theater

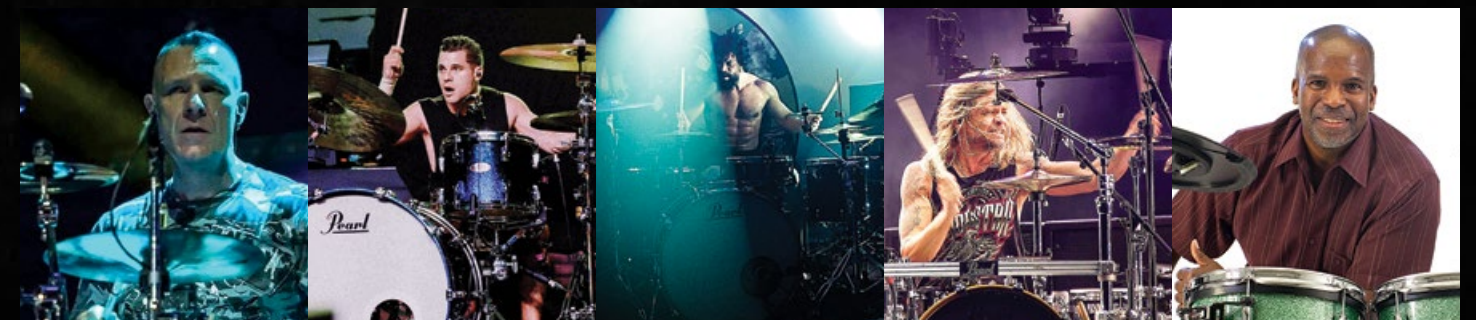

TRACY BROUSSARD Blake Shelton
TROY WRIGHT Independent
TRAVIS ORBIN Darkest Hour
WILL HUNT Evanescence
WILL KENNEDY Yellowjackets / Jazz Legend

PAGES 24 - 25

MASTERS MAPLE COMPLETE

AN ALL MAPLE DRUM SHELL FIT FOR THE MASTERS LEGACY.

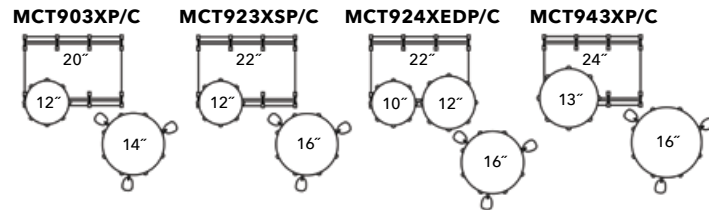

PAGES 26 - 27

SESSION STUDIO SELECT

A COMPLETELY NEW TAKE ON THE FULL SPECTRUM SOUND.

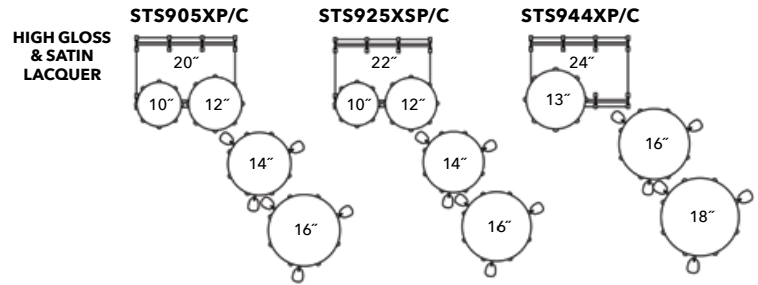
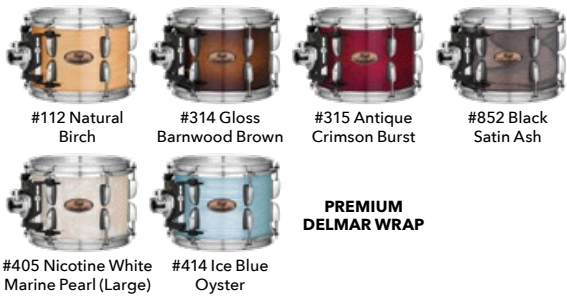

PAGES 28 - 29

PRESIDENT SERIES DELUXE

A MODERN REVIVAL OF THE DARKLY UNIQUE LAUAN SOUND.

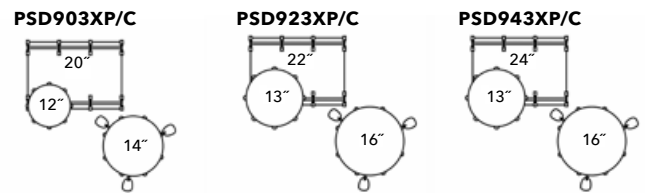

PAGES 30 - 31

CRYSTAL BEAT

THE ORIGINAL SEAMLESS ACRYLIC DRUM SHELL.

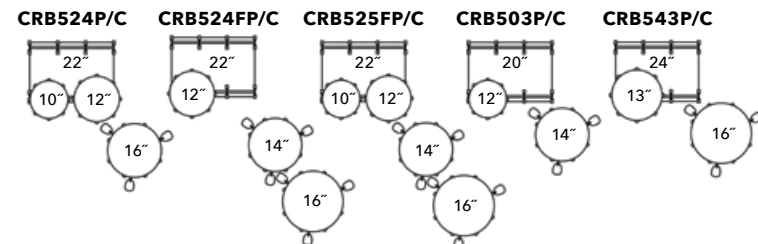

PAGES 32 - 33

DECADE MAPLE

A DRUM KIT 10 YEARS IN THE MAKING.

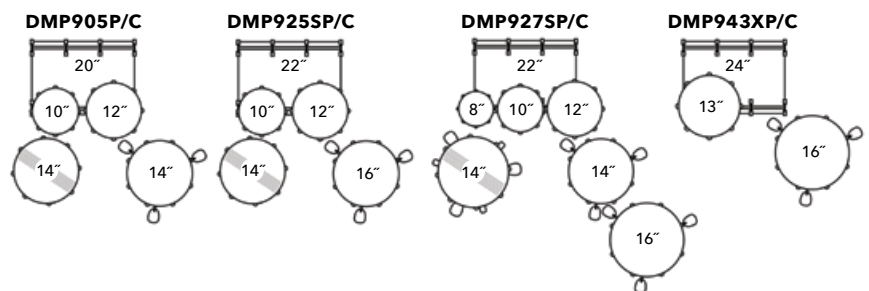

PAGES 34 - 35

EXPORT LACQUER

THE LEGENDS OF TOMORROW, PLAY EXPORT TODAY.

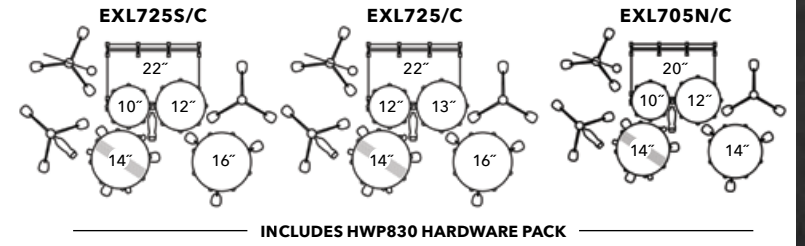

PAGES 34 - 35

EXPORT

THE BEST SELLING DRUM SET OF ALL TIME.

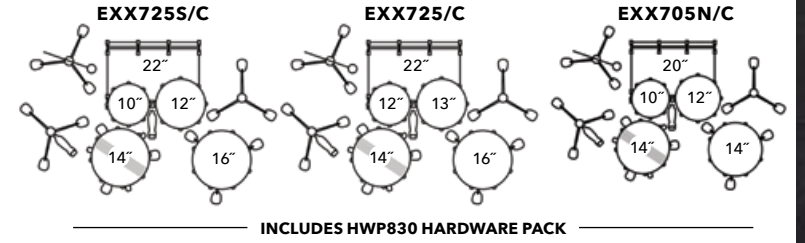

PAGE 36

MIDTOWN

BIG GIG, SMALL RIG, HUGE SOUND.

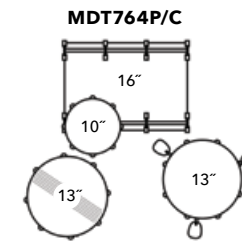
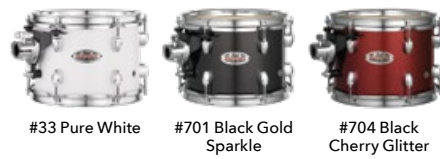

PAGE 37

ROADSHOW JR.

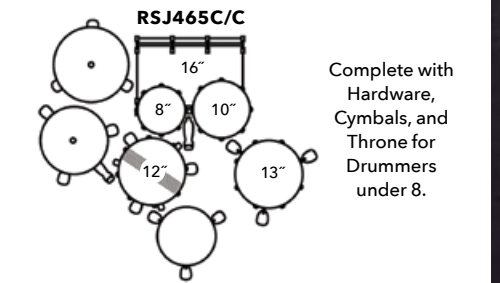

PAGE 37

ROADSHOW

IT'S YOUR TIME TO PLAY, START THE RIGHT WAY.

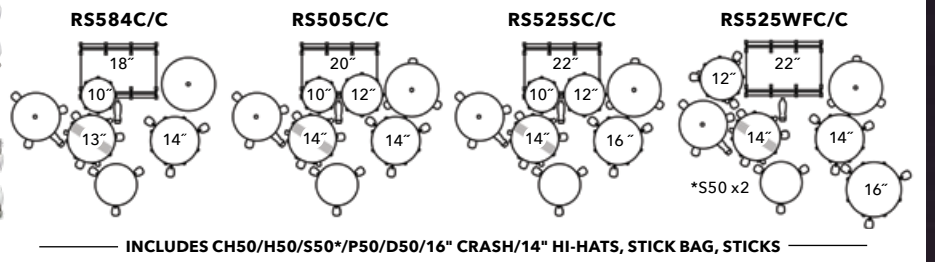

THE BEST WARRANTY IN THE INDUSTRY!*

COMMITTED TO THE HIGHEST LEVEL OF CUSTOMER SATISFACTION.

The Pearl Lifetime Warranty is a statement of confidence to our customers to the reliability of Pearl products. Pearl drums, stands and hardware are designed and manufactured to the highest standards in quality, style, appearance and playing performance. This lifetime warranty reflects a tradition of excellence and a commitment to superior engineering and craftsmanship dedicated to you, the drummer. The Pearl lifetime warranty is our pledge to you that we will proudly stand behind our product for as long as you own it. **BUY IT ONCE, PLAY IT FOR LIFE.**

- Drum Set/Concert wood and metal shells for the Lifetime of the Original Owner.
- Foot pedals, hi-hat stands, cymbals stands, boom cymbal stands, snare drum stands, throne bases, floor-standing tom stands, floor-standing cymbal/ tom stands, concert stands, racks and rack accessories, cymbal holders and multi-clamps for the Lifetime of the Original Owner.
- Some exceptions apply.
- Drum Set claws, tension rods, swivel nuts, spurs, tom brackets, tom holders, strainers, and nuts and bolts for the Lifetime of the Original Owner.
- Rotationally molded cases for the Lifetime of the Original Owner.
- The Lifetime Warranty applies to the aforementioned Pearl products purchased from June 15, 2009.
- * This Lifetime Warranty is valid only in the United States and excludes the Crystal Beat and Roadshow Series.

SPECIAL ORDER LACQUER FINISHES

PAGES 10 - 13

CONFIGURATIONS:

REFERENCE

SONICALLY SELECT DRUM PERFORMANCE.

REFERENCE PURE

UNRESTRICTED TONAL RESPONSE.

RF903XP/C
RFP903XP/C

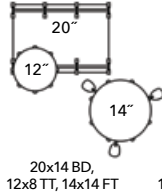

RF924XEDP/C
RFP924XEDP/C

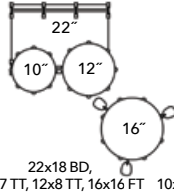

RF924XSP/C
RFP924XSP/C

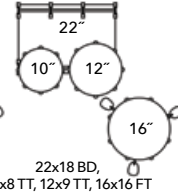

RF923XSP/C
RFP923XSP/C

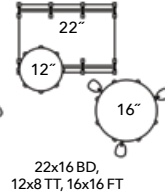

RF943XP/C
RFP943XP/C

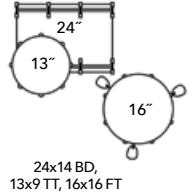

PAGES 20 - 21

MASTERS MAPLE RESERVE

A CLASSIC FORMULA FOR SONIC GREATNESS.



Masters Maple Reserve is available in all 34 Music City Custom special order finishes - see Pages 18-19.



Also available in 28 Special Order Lacquer finishes - see below.

MRV903XP/C

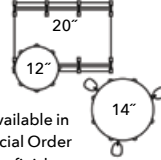

MRV923XSP/C

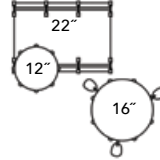

MRV924XEDP/C

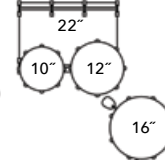

MRV943XP/C

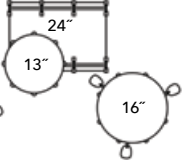

PAGES 22 - 23

MASTERS MAPLE/GUM

THE EVOLUTION OF PREMIUM STUDIO TONE.



Masters Maple/Gum is available in all 34 Music City Custom Special Order finishes - see Pages 18-19. Also available in 28 Special Order Lacquer finishes - see below.

*Shell Packs: Stock, Components: Special Order. Added components in #186 can be special ordered.

MMG904XP/C

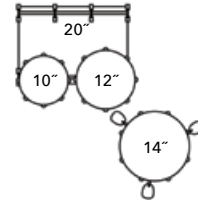

MMG924XSP/C

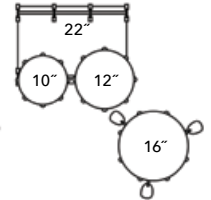

SPECIAL ORDER AVAILABLE IN REFERENCE, REFERENCE PURE, MASTERS MAPLE RESERVE, AND MASTERS MAPLE/GUM SERIES

